

REVISION OF THE CYPRINIDS FROM THE EARLY OLIGOCENE OF THE ČESKÉ STŘEDOHOŘÍ MOUNTAINS, AND THE PHYLOGENETIC RELATIONSHIPS OF *PROTOHYMALLUS* LAUBE, 1901 (TELEOSTEI, CYPRINIDAE, GOBIONINAE)

MADELAINE BÖHME

Ludwig-Maximilians-University Munich, Department of Earth and Environmental Science, Section of Palaeontology, Richard-Wagner-Straße 10, D-80333 Munich, Germany; e-mail: m.boehme@lrz.uni-muenchen.de



Böhme M., (2007): Revision of the cyprinids from the Early Oligocene of the České Středohoří Mountains, and the phylogenetic relationships of *Protothymallus* LAUBE 1901 (Teleostei, Cyprinidae, Gobioninae). – Acta Mus. Nat. Pragae, Ser. B, Hist. Nat. 63(2–4): 175 – 194, Praha. ISSN 0036-5343.

Abstract: Most cyprinid fishes from the Early Oligocene of the České středohoří Mountains belong to the species *Protothymallus elongatus* (KRAMBERGER, 1885). Phylogenetic analysis of the monotypic genus *Protothymallus* LAUBE, 1901 indicates its basal position within the subfamily Gobioninae (gudgeons), near the East Asian (China, Japan) genus *Gnathopogon* BLEEKER, 1860. This is the first fossil evidence of this subfamily in Europe. The revised taxon can be osteologically and morphologically distinguished from *Varhostichthys brevis* (AGASSIZ) (Early Oligocene of Doupovské hory Mountains, locality Valeč/Waltsch) and all other described European Oligocene cyprinids, and it represents an endemic genus and species for the volcano-detritic complex of northeastern Bohemia and southeastern Saxony. The morphology and osteology of *P. elongatus* indicates that these fishes were zoobenthivorous or omnivorous, and preferentially lived in the middle of the water column. From the Seifhennersdorf locality, which provides the best collection of *P. elongatus*, comes a yet undescribed fish species that probably belongs to the Eleotridae (sleepers). Both species occupied different habitats in the Seifhennersdorf-Varnsdorf caldera lake: pelagial habitats by *Protothymallus elongatus* and littoral habitats by eleotrids.

Furthermore, a short synoptic overview about the Eocene and Oligocene ectothermic vertebrates (fishes, amphibians, reptiles) of northern Bohemia and southeastern Saxony is given, and their significance for palaeoenvironmental reconstructions is discussed. Concluding remarks about the subfamily status of the Paleogene cyprinids in Europe summarize that the most ancient European cyprinid assemblages from the Early Oligocene (MP 21–23) contain two subfamilies: Gobioninae with the genera *Protothymallus* and *Varhostichthys*, and Phoxininae with the genus *Palaeorutilus*.

■ Key words: Oligocene, *Protothymallus*, Teleostei, Cyprinidae, Gobioninae

Received March 27, 2007
Issued December 2007

Introduction

The České středohoří Mountains (Böhmische Mittelgebirge) have provided important palaeontological data during the past 150 years. Cenozoic outcrops between Litoměřice (Leitmeritz), Děčín (Tetschen), Bílina (Bilin) and Seifhennersdorf have supplied extraordinarily well preserved floras and faunas. This area therefore became an early centerpoint of scientific research. The beginnings of palaeobotany, with Sternberg, Rossmässler, Engelhardt and Ettingshausen, are closely bound to Bohemia. Some of the most important European fossil floras were first described from this area (e.g. Kundratice/Kundratitz, Kučlín/Kutschlin, Břešťany/Preschen, Zabušany/Sobrussan, Suletice-Berand/Sulotitz-Berand). The faunal record, especially of amphibians, was described by Meyer (1860: salamanders), Wolterstorff (1886, 1887: frogs) and Špinar (1972: frogs). In contrast, the scientific investigation of the fish fauna started comparatively late. Louis Agassiz (1833–1843) didn't mention fishes from this region. August Emanuel Reuss

(1840, and later) investigated the geology and palaeontology of Bohemia using the important fossil collection of Count Lobkowitz, but he mentioned fish faunas only from the westernmost border of the České středohoří Mountains (Kučlín/Kutschlin and Lužice/Luschitz). Considerable palaeozoological finds were made in the mid nineteenth century in some small, briefly opened coal mines (Hibsch, 1926; Walther, 1988) and when geological mapping was intensified. A short note describing fish remains found near Zittau (probably Seifhennersdorf) was given by Giebel (1857). In 1885, Dragutin Gorjanović-Kramberger published a description of two fishes from Varnsdorf: *Chondrostoma babulus* Troschel, and *Chondrostoma elongata* nov. spec. A further species from Varnsdorf, *Thaumaturus lusatus*, was mentioned by Gustav Laube (1900). This species was figured one year later by Laube (1901) and transferred to the new genus *Protothymallus*. The same author further described the following new species (Laube 1901): *Chondrostoma laticauda*, *Lepidocottus gracilis* both from Varnsdorf, *Protothymallus princeps*, *Tinca macropterygia*, and *Squali-*

nus sp. from Kundratice, and *Leuciscus fritschii* from Lbín (Welbine).

After a long hiatus in palaeoichthyological research, Naděžda Obrhelová revised the cyprinids of the České středohoří Mountains in 1970. She synonymised all species so far described (with the exception of *Lepidocottus gracilis*) and placed them in her new genus *Varhostichthys* (type species *Leuciscus brevis* AGASSIZ from Valeč/Waltsch in the Doupovské hory Mountains).

There are several reasons to continue investigating the fish fauna from the České středohoří Mountains. During the past few decades, Harald Walther and some private collectors have sampled a rich and well preserved fish fauna from the dumps of the Seifhennersdorf locality, which was derived from other layers than those that supplied the older material, and which was unknown to the previous researchers. A revision of the type material of Agassiz, Laube and Obrhelová, as well as the rediscovery of the lost type of "*Leuciscus stephani*" v. MEYER from Valeč (Waltsch; Doupovské hory Mountains), showed that *Leuciscus brevis* AGASSIZ can not be synonymised with any fish from the České středohoří Mountains. Thus, the genus *Protothymallus* should be reestablished, as suggested by Gaudant (1996).

Beside the taxonomic revision of *Protothymallus*, the present article will provide data about its syn- and autoecology, and the importance of this fish and other ectothermic vertebrates for the reconstruction of the palaeoenvironment.

Geological overview

The České středohoří Mountains (Böhmisches Mittelgebirge) comprise a large neovolcanic complex in the northeast of the Czech Republic. At the end of the Eocene and during the Oligocene, alkaline magmas intruded the intersection of the Labe/Elbe and Ohře lineaments (Kopecký et al. 1990). Sands and sandstones of Late Eocene age, tuffs, claystones, diatomites and coal seams of Early to Late Oligocene age crop out below the alkaline basaltic rocks (Hibsch 1926; Hurník and Knobloch 1966).

The Seifhennersdorf-Varnsdorf Locality

Although a number of studies have been published in the past few decades about the geology of the Seifhennersdorf deposits, no more recent information about Varnsdorf has appeared since a profile by Jokély (1859). Nevertheless, one can see from Jokély's profile that the deposits of the old mines of Varnsdorf, situated only 1 km SE of Seifhennersdorf, belong to the same sedimentary basin. All data from Seifhennersdorf can therefore be referred also to Varnsdorf.

According to the geological profile of the Seifhennersdorf section (Ahrens 1957), a 40 to 50 m thick lacustrine succession of tuffites, mudstones and diatomites lies above kaolinized granite (Lužice/Lausitz or Rumburk Granite) and a granitic arkose of variable thickness. The top is formed by a 20 m thick basalt layer. The sedimentary succession contains five diatomite seams that have a cyclic appearance. Coarse grained lapilli tuffites are overlain by non-laminated mudstones, followed by finely laminated diatomites (the so called *Polierschiefer*). The uppermost seam is

overlain by a 40 to 50 cm thick (maximum 170 cm) layer of brown coal (at Varnsdorf 70 cm). Hein and Schwab (1958) described silicified roots from this horizon. They interpreted this as an early diagenetic process due to an excess of silica under a weakly acidic pH value. The silica-rich lake water enabled the development of silicate-incorporating organisms like freshwater sponges (in the coal) and diatoms (in the diatomite and clay stones).

Most of the faunal and floral specimens come from the diatomite (Walther 1996). All the finds from 1856 to 1864 were derived from the top seam. The diatomite of seams 4 and 5 was mined again from 1951 to 1956. All newer specimens are derived from these seams.

According to the tectonic and sedimentological studies of Ahrens (1959), the Seifhennersdorf-Varnsdorf structure is volcano-tectonic in origin, with a cyclic subsidence most likely connected with a caldera. A depression, and subsequently a lake, formed after the evacuation of the magma chamber. Tuffite eruptions interrupted the sedimentation in the lake and led to the erratic subsidence of the basin.

The Kundratice (Kundratitz) Locality

In 1878 Raffelt discovered the Kundratice (Kundratitz) locality, also known as "Jesuitengraben bei Kundratitz" or "Am frischen Brünnele". A detailed description of the locality and the early excavations on the western slope of Winterberg, 1200 m north of Kundratice, is given by Engelhardt (1882). About the geologic situation he remarks only that diatomite, organic rich shales (*Brandschiefer*), and tuffite cropped out below boulders of basalt. Bůžek et al. (1978) indicate a thickness of 4 m of sediments at the Engelhardt locality. In the 1890s, Menzel collected fossils a "few hundred meters below the classic locality 'Am frischen Brünnele'" (Menzel, 1898). During research at *Jesuitengraben* in 1991, the present author found that the locality of Engelhardt is now inaccessible, but that fossiliferous sediments are exposed near an outcrop which was probably that of Menzel. This is situated 1800 m NNW of Kundratice, in the *Jesuitengraben*, on the right river bank coming from Čerčeniště (Czersing), about 8 to 10 m above the river. In a sequence of lapilli rich tuffs, there occurs a 0.25 to 0.4 m thick layer of light to dark brown, bituminous and nonlaminated mudstone intercalated with finely laminated diatomite, and a fine coal band of 2 to 3 cm thickness. Because of landslide processes, which occur in many places of the *Jesuitengraben*, the profile was heavily disturbed. Fossils could be recovered mostly from the clay stone. They included a leaf flora (described in Kvaček and Walter 1998), a few disarticulated fish remains, and a postmetamorphic fragment of a frog (*Palaobatrachus* sp.). A distinct layer within the mudstone is rich in bivalve imprints belonging to the genus *Pisidium*, and also unidentifiable freshwater gastropods.¹ Such an enrichment of molluscs was previously unknown from Kundratice and the entire volcanic complex of the České středohoří Mountains. Due to the complicated tectonic conditions and its parautochthony, this profile could not be correlated to the Engelhardt excavation.

In 1956 a 10.7 m thick diatomite/clay stone horizon (84.4–95.0 m) was drilled (borehole KU-1) near the Engel-

¹ The material is deposited in the SMMGD (Böhme collection).

hardt excavation (profile in Bůžek et al., 1978: Fig. 1). Two thin layers of limnic sediments below this horizon suggest the repeated development of lake environments interrupted by tuff eruptions. Deeper in the same borehole, a 7.8 m thick horizon was sampled (159.5–167.3 m), which, based on the palaeotropical macro and micro flora (Konzalová, 1981; Bůžek et al. 1978; Kvaček and Walther 1998) and the percomorph fish *Properca bispinella* (Obrhelová 1976; Micklich and Böhme 1997), is of Late Eocene age.

The Hlinná (Hlinnai), Skalice (Skalitz), and Lbín (Welbine) Localities

During the nineteenth century, these three temporary outcrops revealed a rich Oligocene flora (Procházka, 1955) and fish fauna. They have nothing in common with the old coal mining sites of similar name which are of Late Eocene age (see below). In Hlinná, bituminous shale and tuffite cropped out between 420 and 440 m NN (?). In Skalice (indicated on old labels as Žitenice near Skalice), diatomite was found on the road from Poustevna near Skalice (community) to Nový Dvůr (in the direction of Staňkovice) at 440 m NN, and on the northern side of the landslide to the Lbín (Welbine) rivulet at 430 m NN. The very thin laminated diatomite of Lbín (Welbine) was found on the road from Mentourov (Mentau) to Lbín, west of U Mlýna (Mühlhäusel) at 435 m NN.

Late Eocene sediments in the region north of Litoměřice (Leitmeritz)

Some remarks should be made about the older strata of this region because the similar names of localities can lead to confusion. Sediments of the Late Eocene (Middle Oligocene in Hibsich, 1926) have long been known. These sediments comprise sands, sandstones and sometimes conglomerates, clay stone, and brown coal. Hibsich (1926) pointed out that some of the detritic sediments, which lay concordantly above the Turonian, may be of Late Cretaceous age. This was confirmed later by Vachtl (cit. in Hurník and Knobloch 1966: 56). A Late Eocene age can be proven only by biostratigraphy. This is the case for the locality “Schüttenitzer Pfarrbusch” near “Skalitz, Schüttenitz und Pohorschán” (Hibsich and Seemann, 1913). The outcrops of loose, scattered blocks of siliceous sandstones are located 1200 m northeast of Žitenice (Schüttenitz) on the right side of the road from Žitenice to Skalice (Skalitz). This locality, later called Žitenice, contained a rich flora that was studied by Engelhardt (1876). In his first description of this flora, Engelhardt pointed out its notable similarities to that of Staré Sedlo (Altsattel), which was later confirmed by Knobloch et al. (1996). The Staré Sedlo Formation is regarded today as Late Eocene in age, and is correlated with the floral complex of Zeitz and palynozone (SPP) 16 to 18 (Bůžek et al. 1990). This locality therefore has nothing in common with the Oligocene diatomites from “Žitenice near Skalice”.

Two boreholes were drilled in 1956: LB-1 near Lbín (Welbine) and UC-9 near Hlinná (Hlinnai). Both reached sedimentary layers with tuffite, diatomite and up to four small seams of brown coal (profile in Bůžek et al. 1978). Finds of *Doliostrongobus certus* and *Compositopolis rhizophorus* indicate a Late Eocene age (Bůžek et al. 1978; Konza-

lová 1981; Kvaček 2002). This leads to the conclusion that the brown coal mining near Hlinná and the drillings from 1898 and 1899 near Lbín that contain two coal seams, both mentioned by Hibsich and Seemann (1913; Hlinná coal-mining since 1828 to the 1860th and 1879–1881; two seams of 1.9 m and 1.9 to 2.5 m thickness), can be correlated with the profile of the 1956 drilling, which is in concordance with the position of the seams above sea level. This could indicate that all brown coal seams in the region north of Litoměřice (Leitmeritz) are probably of Late Eocene age, and that during the Oligocene no significant coal formation occurred. Furthermore, the localities (drillings) Lbín (= Welbine, LB-1) and Hlinná (=Hlinnai, UC-9) in Konzalová (1981), as well as the coal-bearing strata of Lbín and Hlinná in Hibsich and Seemann (1913), cannot be correlated with the fauna and flora of the diatomite near Lbín/Welbine (Mühlhäusel) and Hlinná, which are of Early Oligocene age.

Systematic Palaeontology

Taxonomic abbreviations:

A	– anal fin formula
art	– articular
av	– abdominal vertebra
bra	– branchiostegals
chy	– ceratohyal
CIO	– infraorbital canal
cl	– cleithrum
co2	– second circumorbital
co5	– fifth circumorbital
cor	– coracoid
CPM	– preoperculo-mandibular canal
CSO	– supraorbital canal
CST	– supratemporal canal
D	– dorsal fin formula
d	– dentary
f	– frontal
fc	– foramen carotis
ff	– facial foramen
fgo	– fossa glenoidalis operculi
hy	– hyomandibula
iop	– interopercle
iv	– intermediate vertebra
keth	– kinethmoid
la	– lacrimal = first circumorbital
L bas n	– length of neurocranial base
leth	– lateral ethmoid
LR	– scales along median longitudinal scale row
L/W-index	– length and width relationship
mcor	– mesocoracoid
meth	– mesethmoid
mf	– maxillary foramen
mpt	– metapterygoid
mx	– maxilla

na2+3	– second and third neural arch
nc	– neural complex
ns4	– fourth neural spine
occ	– occipital
op	– opercle
osph	– orbitosphenoid
pa	– parietal
pal	– processus anterior lateralis
pan	– preanal vertebra
pam	– processus anterior medialis
pasph	– parasphenoid
pav	– postabdominal vertebra
pcl	– postcleithrum
pd	– predorsal vertebra
pkm	– processus kinethmo-maxillaris
pl	– palatine
pmx	– premaxilla
pop	– praeopercle
ppm	– processus palato-maxillaris
ppt	– pterotic process
pra	– processus ascendens
pro	– prootic
pt	– pterotic
ptsph	– pterosphenoid
qu	– quadrat
r5, 6	– ribs of the fifth and sixth vertebra
ra	– radials
seth	– supraethmoid
sc	– scapula
scl	– supracleithrum
SL	– standard length
sn3–5	– third to fifth supraneural
socc	– supraoccipital
sop	– subopercle
sph	– sphenotic
sy	– symphysis
tf	– trigeminal foramen
TL	– total length
tr	– tripus
v1–4	– first to fourth vertebra centrum
vmp	– ventro-medial process
vt	– total number of vertebrae
∅	– mean

Collection abbreviations:

UL	– University Leipzig, palaeontological collection
SMMGD	– Staatliches Museum für Mineralogie und Geologie zu Dresden
NMP	– National Museum Prague
NHNV	– Natural History Museum Vienna
GBAW	– Geologische Bundesanstalt Vienna
MNB	– Natural History Museum Berlin

Class Actinopterygii COPE, 1887

Division Teleostei MÜLLER, 1846

Order Cypriniformes BLEEKER, 1859

Family Cyprinidae BONAPARTE, 1832

Subfamily Gobioninae RENDAHL, 1928

Genus *Protothymallus* LAUBE, 1901

v 1901 *Protothymallus* nov. gen. – Laube, Synopsis, p. 22, pl. IV, fig. 1–4.

v 1969 *Varhostichthys* nov. gen. – Obrhelová, Karpfenfische im Süßwassertertiär, p. 50 (partim).

Type species: *Chondrostoma elongata* KRAMBERGER, 1885.²

Diagnosis: See diagnosis of the type species.

Stratigraphic and geographic occurrence: Early Oligocene (~32 Ma) probably to early Late Oligocene (~28 Ma) of the České středohoří Mountains (SE Saxony, NE Bohemia).

Protothymallus elongatus (KRAMBERGER, 1885)

non, v 1843

Leuciscus brevis nov. spec. – Agassiz, Recherches sur les poissons fossiles, vol. 5, p. 55; pl. 51c, fig. 4.

non, nv 1857

Leuciscus oeningensis AGASSIZ, 1832 – Giebel, Tertiäre Wirbelthierreste bei Zittau, p. 316.

+ 1885 *Chondrostoma elongata* nov. spec. – Kramberger, Palaeoichthyologzki prilozhi, p. 39, pl. 2, fig. 2, 3.

1885 *Chondrostoma bubalus* TROSCHERL, 1854 – Kramberger, Palaeoichthyologzki prilozhi, p. 38.

1886 *Chondrostoma bubalus* TROSCHERL, 1854 – Kramberger, Palaeoichthyologische Beiträge, p. 133 – 134.

1886 *Chondrostoma elongata* KRAMBERGER, 1885 – Kramberger, Palaeoichthyologische Beiträge, p. 133.

1900 *Thaumaturus lusatus* nov. spec. – Laube, Salmonoiden der Braunkohlenformation, p. 20.

v 1901 *Protothymallus lusatus* (LAUBE, 1900) – Laube, Synopsis, p. 23, pl. IV, Fig. 1–3.

v 1901 *Protothymallus princeps* nov. spec. – Laube, Synopsis, p. 25, pl. IV, Fig. 4.

v 1901 *Tinca macropterygia* nov. spec. – Laube, Synopsis, p. 36, pl. V, fig. 6; –pl. VIII, fig. 4.

v 1901 *Gobio major* nov. spec. – Laube, Synopsis, p. 38, pl. V, fig. 7.

v 1901 *Leuciscus fritschii* nov. spec. – Laube, Synopsis, p. 43, pl. VII, fig. 1.

v 1901 ? *Squalinus* spec. indet. – Laube, Synopsis, p. 44, pl. VII, fig. 3.

v 1901 *Squalinus* sp. indet. – Laube, Synopsis, p. 44, pl. VIII, fig. 5.

1901 *Chondrostoma bubalus* (TROSCHERL, 1854) – Laube, Synopsis, p. 45.

v 1901 *Chondrostoma elongata* KRAMBERGER, 1885 – Laube, Synopsis, p. 46.

v 1901 *Chondrostoma laticauda* nov. spec. – Laube, Synopsis, p. 46, pl. 7, fig. 2.

v 1969 partim *Varhostichthys brevis* (AGASSIZ, 1843) – Obrhelová, Karpfenfische im Süßwassertertiär, p. 50.

non 1970

Chondrostoma elongata KRAMBERGER, 1885 – Anđelković, Fossile Fische aus Serbien, p. 306, pl. IX, Fig. 1, 2.

² The correct publication year is 1885, not 1884 as stated in Anđelković (1970, 1989) and Gaudant (1996).

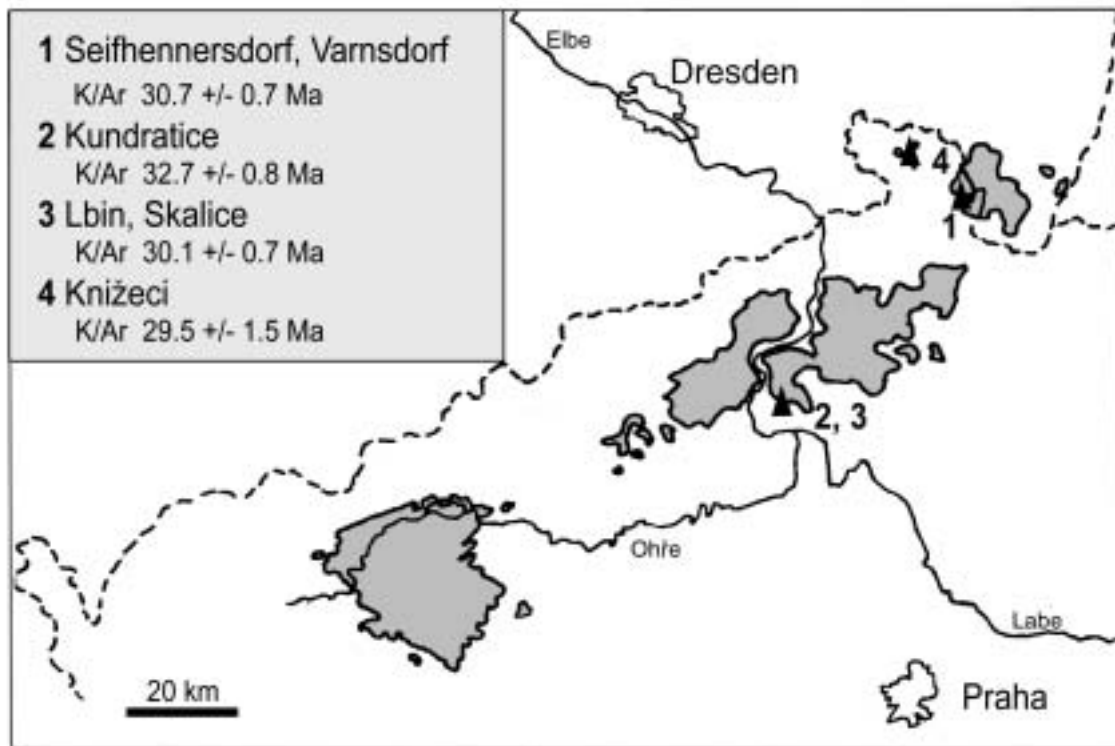

Text-fig. 1: Distribution of Cenozoic volcanites (gray shaded areas) along the Ohře/Eger rift and the position of localities with *Prothymallus elongatus* (KRAMBERGER, 1885) including their K-Ar ages (from Bellon et al. 1998).

Plate 1: *Prothymallus elongatus* (KRAMBERGER, 1885), articulated adult skeleton (SL 125 mm) from Seifhennersdorf (MNB MB.f.2820), (Photo: Harre, Berlin).

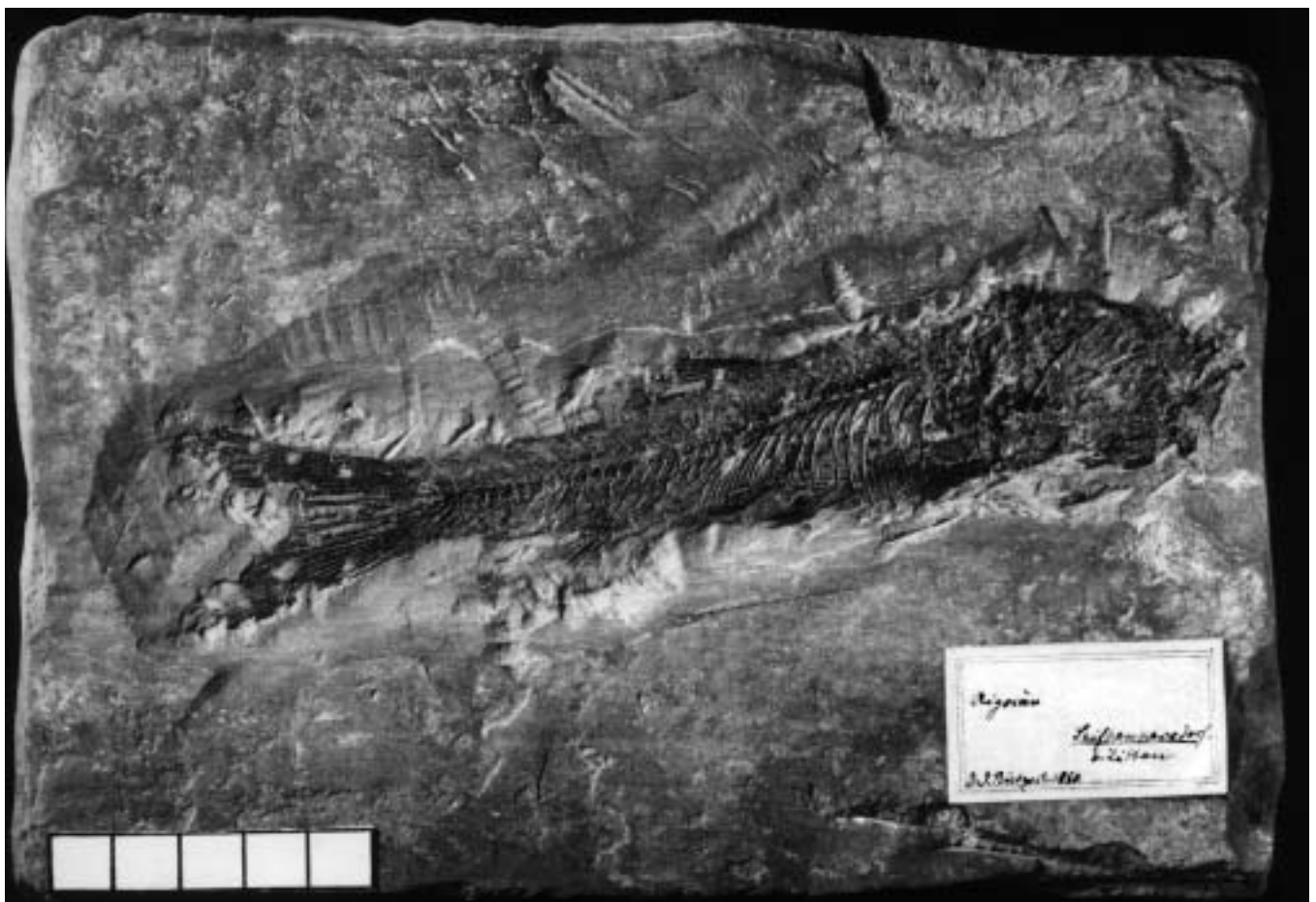

v 1970 *Varhostichthys brevis* (AGASSIZ, 1843) – Obrhelová, Vorläufer von *Tinca tinca*, pl. 1–7; fig. 1–14.
non 1989

Chondrostoma elongata KRAMBERGER, 1885 – Anđelković, Tertiary fishes of Yugoslavia, p. 73, pl. V, fig. 2.

1993 "*Chondrostoma*" *elongata* KRAMBERGER, 1885 – Gaudant, Eocene Freshwater Fish-Fauna, p. 235.

1996 *Protothymallus elongatus* (KRAMBERGER, 1885) – Gaudant, Rectifications de nomenclature, p. 94.

Material: A total of 121 specimens.

8 specimens from Varnsdorf: GBAW – 1885/3/1 (type of *Chondrostoma elongata* KRAMBERGER, 1885); NMP – Tc 8 (type to *Thaumaturus lusatus* LAUBE, 1900), Pc 256 (original to, Laube 1901: pl. 4, fig. 1), Pc 257 (type to *Chondrostoma laticauda* LAUBE, 1901: pl. 7, fig. 2), Tc 7 (original to *Protothymallus lusatus* LAUBE, 1901: 46 and Obrhelová, 1970: pl. 4, fig. 1), Pc 323 (original to Obrhelová, 1970: pl. 1, fig. 1), Pc 324, Pc 2724.

86 specimens from Seifhennersdorf: NMP – Tc 6; SMMGD – SaT198 original to *Protothymallus lusatus*, LAUBE 1901: pl. 4, fig. 2), SaT609/Dr.379 (original to Obrhelová 1970 : pl. 5, fig. 2), SaT437/Dr.377 (original to Obrhelová 1970: pl. 5), SaT62/Dr.6, SaT 63, 85, 88–91, 96, 98, 99, 101, 104, 106, 110, 113, 117, 120, 121, 125, 126, 136, 142, 143, 151, 153, 156–159, 161, 163, 165, 167, 168, 174, 177–180, 184, 188, 190, 197, 202, 204, 206, 208, 210, 212, 214–216, 221, 224, 301, 309, 344, 347, 361–364, 371, 380, 381, 384, 392, 399, 409, 413, 414, 431, 433, 466, 481,

492, 494, 620, Sf.3925, and two uncatalogued specimens; SMMGD collection Harald Walther, Dresden (uncatalogued juvenile specimen); MNB – MB.f.2820.

8 specimens from Seifhennersdorf or Varnsdorf: UL – V1–3, and five uncatalogued specimens.

12 specimens from Kundratice/Kundratitz (Hlinná): NMP – Pc 339, Pc 342, Pc 309+308 (type of *Squalius* sp. Laube 1901), Pc 350+351 (original to Laube 1901: pl. 8, fig. 4, 5), Pc 318 (type of *Protothymallus princeps* LAUBE, 1901), Pc 319; NHMV – 1883, and five additional uncatalogued specimens).

5 specimens from Skalice/Skalitz (Žitenice/Zittenitz): NMP – Pc 325, Pc 327, Pc 2721, CM1407, CM1431.

2 specimens from Lbín/Welbina: NMP – Pc 311 (type of *Leuciscus fritschii* LAUBE, 1901), CM1429.

Holotype: Figured by Gorjanović-Kramberger 1885, pl. 2, fig. 2 from Varnsdorf; deposited in the Vienna Collection of the Geologische Bundesanstalt Wien (GBAW – 1885/3/1).

Locus typicus: Varnsdorf near Rumburk (NE-Bohemia).

Stratum typicum: Laminated diatomite at the base of the Nephelinbasanites, Late Rupelian; radiometric (K/Ar) date 30.2 ± 1.6 Ma (according to Bellon et al. 1998).

Stratigraphic and geographic occurrence: Early Oligocene (Middle to Late Rupelian) probably to early Late Oligocene (earliest Chattian) of northeastern Bohemia and southeastern Saxony (Fig. 1),

Plate 2: *Protothymallus elongatus* (KRAMBERGER, 1885), articulated juvenile skeleton (SL 30.5 mm) from Seifhennersdorf (SMMGD Harald Walther collection, without number), (Photo: Bastian, Dresden).

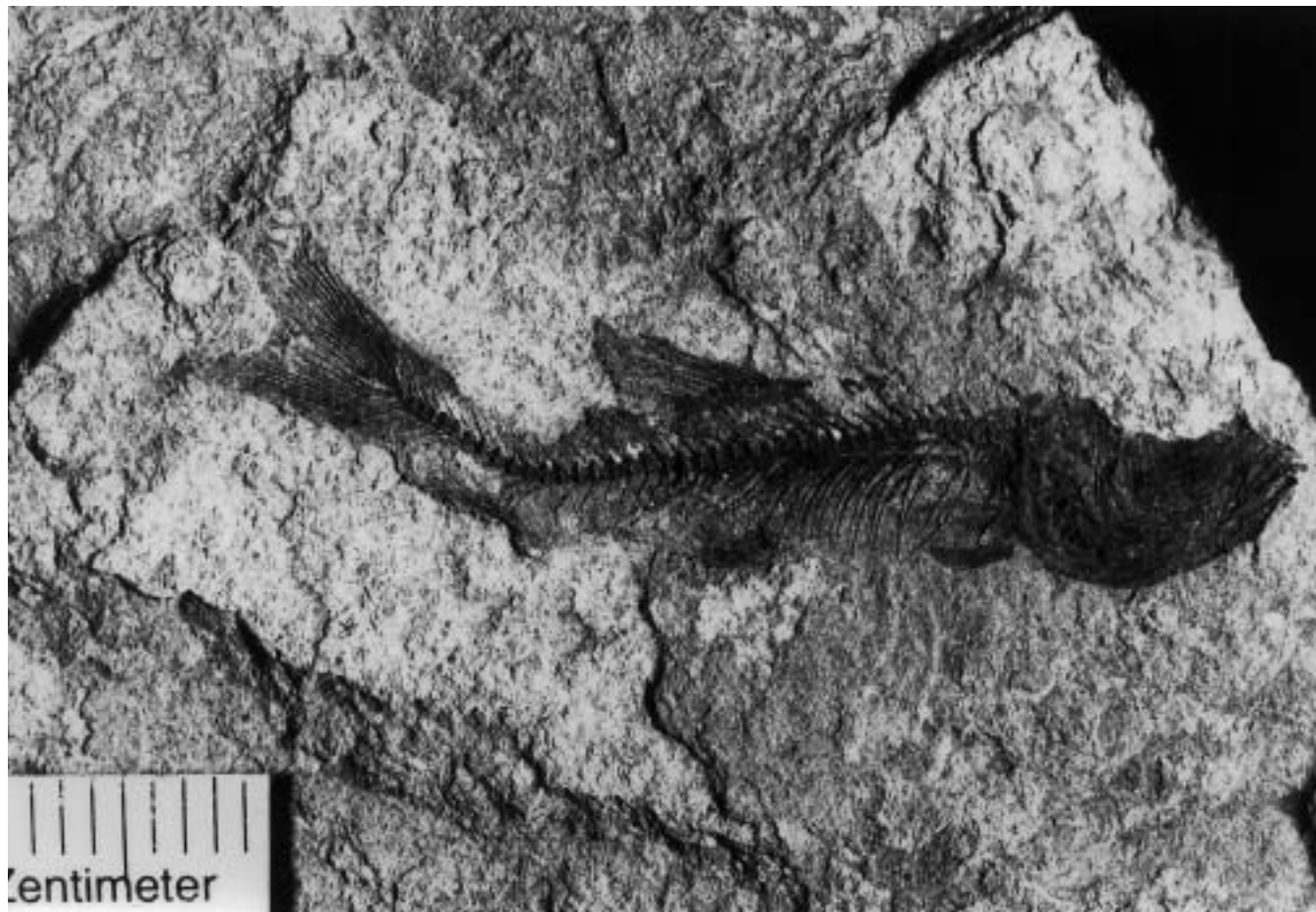

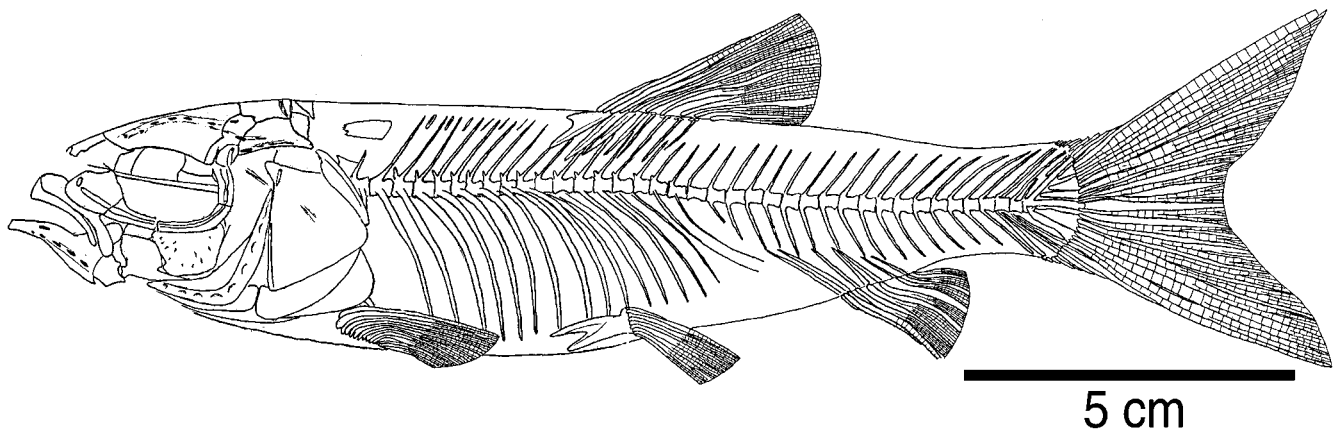

Text-fig. 2: Reconstruction of *Protothymallus elongatus* (KRAMBERGER, 1885) based on NHMV-1883, SMMGD-SaT 173, and UL-V2.

from the localities Seifhennersdorf, Varnsdorf, Kunderatice, Lbín and Skalice. Radiometric (K/Ar) dates 32.7 ± 0.8 Ma (Kunderatice) to 30.1 ± 0.7 Ma (Lbín). Obrhelová and Obrhel (1987) report additional records from Knížecí (Pirskenberg), radiometric (K/Ar) dates 29.5 ± 1.5 Ma (all ages according to Bellon et al. 1998).

A m e n d e d d i a g n o s i s: Relatively slender, medium-sized Gobioninae (SL max. 140 mm, TL max. 190 mm); mouth terminal; lower jaw long (54–58% L bas n.); supraethmoid broader than long, with prominent medial and lateral grooves; frontal and pterotic separated by the sphenotic; CSO divided, medial branch ending on the distal frontal near the crosspoint of the frontal, parietal, and sphenotic, lateral branch passing across the sphenotic to the pterotic parallel to the CIO; CPM interrupted on the articular, on the anterodorsal corner of the operculum with canal-segment; pharyngeal tooth formula 5.2.; dorsal fin usually with 7 divided soft rays (D [2]3/7[8]), anal fin generally with 6 (A [2]3/6); vertebrae count 40–41, 23 or 24 abdominal and 17 post-abdominal vertebra³; lateral line is missing or incomplete (reaching to the ventral fin); scales are small and numerous (>50 to 70 along the median longitudinal scale row), without basal radii, but with convergent caudal radii.

Description

B o d y a n d s i z e (pl. 1 and 2, text-fig. 2): *Protothymallus elongatus* is a medium-sized, slender, and laterally compressed fusiform fish with a maximum standard length of 140 mm and a maximum total length of 190 mm.

N e u r o c r a n i u m (text-fig. 3): The neurocranium appears massive, without fontanelles (#29-0⁴), and shows a nearly triangular outline due to the broad posterior part. The pterotic is compact and restricted to the posterolaterale corner of the neurocranium (#20-0). A processus pteroticus is developed. Frontal and pterotic are separated by a median broadened sphenotic. The fossa glenoidalis operculi is expanded onto the frontal. A frontal-sphenotic foramen is absent (#2-0).

E t h m o i d (text-fig. 3): The supraethmoid is broadened, the width/length quotient is 1.65. Its front shows a flat medial and two slightly less prominent lateral sulci (#3-0). Two flat notches are developed lateral to the medial sulcus, so the front of the bone has an undulating appearance (#32-0). The

mesethmoid is very pronounced with a deep rostral sulcus for adopting the kinethmoid. The lateral ethmoids become narrow distally. The kinethmoid is cylindrically and only slightly elongated (#27-0). On their dorsal side, the insertion points of the ligaments connecting to the ethmoid are well pronounced. The central part of the vomer (Text-fig. 8F) has a rounded outline (#28-0), distally passing to a pointed process, whereas proximally a deep oval sulcus is developed corresponding dorsally with the rostral sulcus of the mesethmoideum. No prolonged praeethmoid cartilage is discernable (#26-0). The processes of the palatine are short (#33-0).

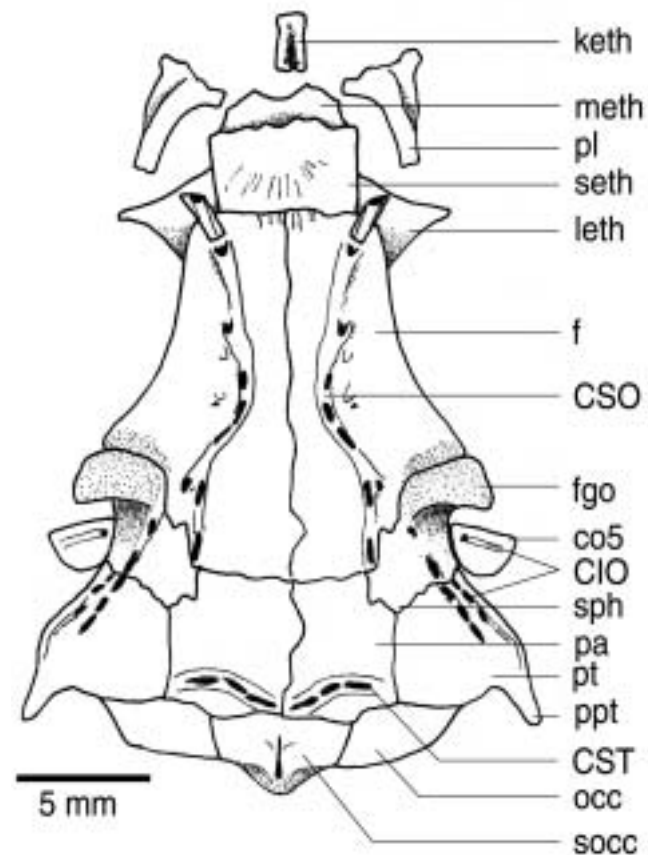

Text-fig. 3. *Protothymallus elongatus* (KRAMBERGER, 1885): reconstruction of the neurocranium in dorsal view based on UL-V2.

³ Note that the number of fin rays and vertebrae differ from Gaudant (1996).

⁴ The number of character states refer to Table 1 and the section entitled "Phylogenetic relationships of *Protothymallus*."

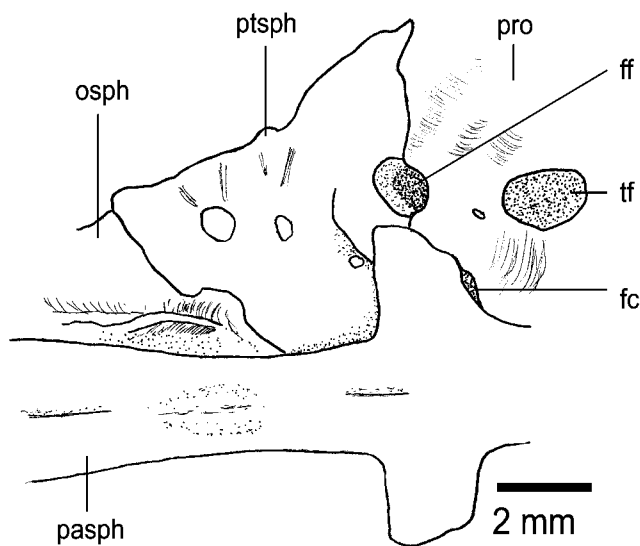

Text-fig. 4. *Protothymallus elongatus* (KRAMBERGER, 1885): ventral detail of the neurocranium (SMMGD SaT-168).

Orbital and otic region (text-fig. 4): The orbitosphenoid is inserted through the interorbital septum on a dorsal ridge at the parasphenoid. This ridge is poorly developed and is not a part of the septum (#13-1). The foramen interorbitale appears very flat. The anterior opening of the trigeminal foramen is positioned at the anterior edge of

the prootic (#15-0), near the boarder between prootic and pterospheonoid. The body of the parasphenoid is comparatively broad and shows no dorsal orientated lamina at the end of the orbital opening.

Viscerocranium, suspensorium (text-fig. 5): The hyomandibula is relatively long (46–50% L bas.n.). The praeopercular ridge (crista praeopercularis hyomandibularis) of this bone is broad; its articulation facet to the pterotic (caput glenoidale posterior) is not elongated in the caudal direction. The angle between the praeopercular ridge and the plane of both cranial hyomandibula articulations measures 50°. The quadrate and the metapterygoid are closely connected. The praeopercular branches encompass an angle of about 105°.

Upper jaw (text-fig. 6): The maxilla is sigmoidally vaulted, distally ventrally bent, and broadened into a spoon shape (#4-1). The dorsal process (processus ascendens) is relatively high and slightly backwards-directed. The ventral border is formed by a broad inward benched lamella. The head of the maxillar shows a dorso-medial (processus kinethmo-maxillaris) and a dorso-lateral condylus (processus palato-maxillaris), both separated by a significant groove. A maxillary foramen is present (#8-0), as are a short ventro-lateral process, a larger dorso-lateral process (processus ascendens), and a ventro-medial process.

The ventro-medial process is relatively long (but mostly broken, see text-fig. 6), connecting both maxillas through a ligament.

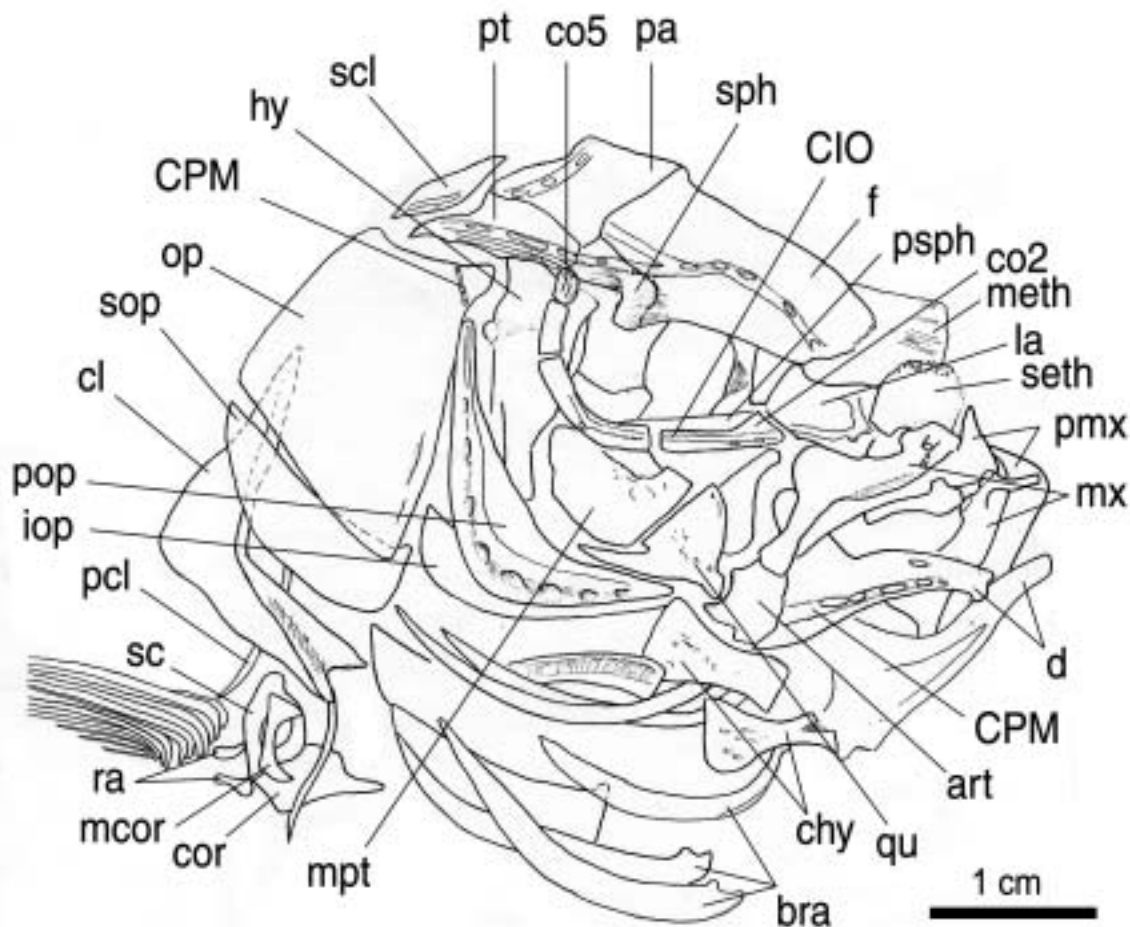

Text-fig. 5. *Protothymallus elongatus* (KRAMBERGER, 1885): partly disarticulated skull (SMMGD SaT-141).

The maxillary foramen exits beneath the dorso-lateral condylus. It is interpreted by Howes (1981) as the passage of the nervus trigeminus, supplying a rostral barbel. This foramen certainly appears in cyprinids without rostral barbels, such as *Ctenopharyngodon idella* (Xenocyprinidae) and *Tinca tinca* (Tincinae), although not in such a size as in the barbel-bearing *Cyprinus carpio* (text-fig. 7). In both cases the nerve supplies the tissue of the lips. It is probable that the rostral barbel becomes secondarily lost in *Ctenopharyngodon* and *Tinca* (Howes 1981). Whether the small ventro-lateral process immediately postero-ventral of the foramen supports a rostral barbel (as expected in Patterson 1984 for *Chanoides macropoma*) is difficult to discern. The existence of a rostral barbel in *Protothymallus* is at present not proven.

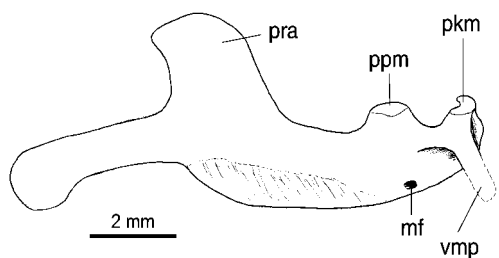

Text-fig. 6. *Protothymallus elongatus* (KRAMBERGER, 1885): maxilla (the arrow marks the maxillary foramen; SMMGD SaT-165: 1).

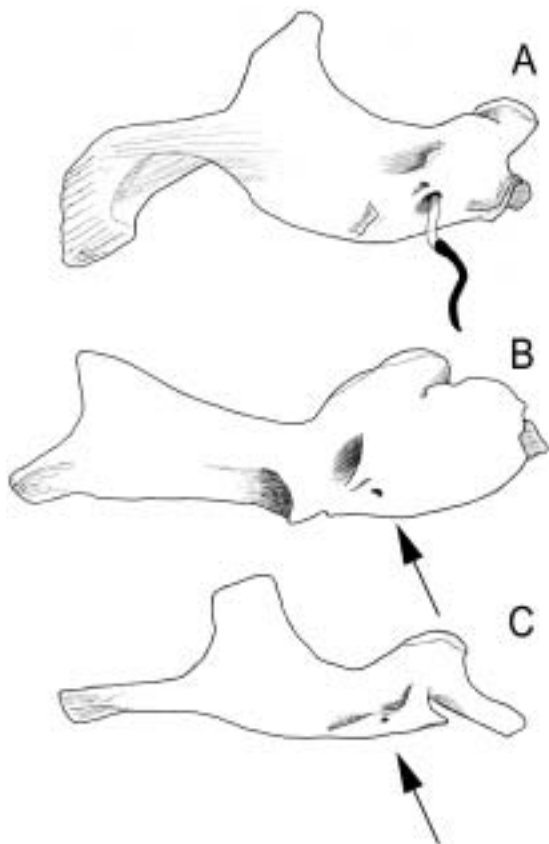

Text-fig. 7. Maxillary (labial view) with maxillary foramen (arrows) from A – *Cyprinus carpio* (Cyprininae) showing the schematic reconstruction of the nervus trigeminus and the rostral barbel, B – *Ctenopharyngodon idella* (Xenocyprininae), C – *Tinca tinca* (Tincinae), (images not to scale).

The rostral process of the praemaxillaria is short (#35-0).
Lower jaw (text-fig. 5): The mandible is long (54–58% L bas n.). The dentary is stretched, very narrow and ventrally arched in the symphyseal area. The symphysis is slightly ventro-caudally broadened forming a "symphyseal knob" or a "chin". A foramen mentale is present. The ventral lamina (*Ventralsaum* of Obrhelová 1970) is expressed only in the rear below the coronoid process. The articular is not involved in this process. The coronoid process is low compared to the length of the lower jaw and bends slightly backwards. The articular is relatively large and bears a pronounced supraglenoid process. The articulation between the articular and the quadrate lies beneath the anterior third part of the orbit. The glenoid fossa of the articular is broad and deep. Both observations point to an enlarged angle for the jaw opening. The mouth was probably terminal (#36-0).

Circumorbitalia (text-fig. 5): The first circumorbital (lacrimal) is large (24% L bas.n.), suboval and bears a pronounced lateroethmoid process. The circumorbitals II-IV are slim and without variation in width. The fifth circumorbital (dermosphenotic) is shortened but well developed. A supraorbital could not be detected and is probably missing. (#16-0). The opening of the orbit is slightly stretched.

Hyoid- and branchiostegal apparatus (text-figs 5, 8 C, D): The ceratohyal appears compact (length/width quotient 1.5) and bears some papillary tubercles and pits along the corpus. The facies epihyalis of the bone is bent. The epihyal shows a compact supraglenoid process (contrary to Obrhelová, 1970: 144, fig. 7c; the unique epihyale that Obrhelová studied came from Markvartice. According to the present study, the large cyprinids from Markvartice do not belong to the species *P. elongatus*).

Pharyngeal dentition (text-fig. 9): The dentition of the pharyngeal bone has two rows (#38-0), with five teeth on the primary and two teeth on the secondary row (tooth formula 5.2.). This is in contrast to the observation of Obrhelová of 6 to 7 teeth on the primary and 1 tooth

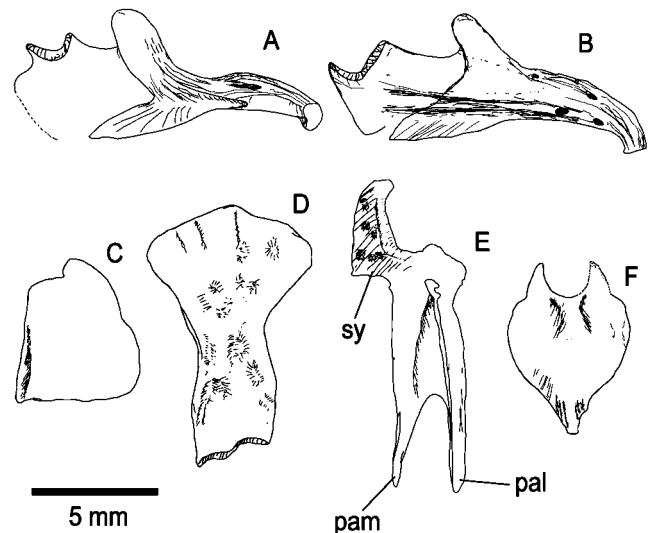

Text-fig. 8. *Protothymallus elongatus* (KRAMBERGER, 1885): A – dental in lingual view (SMMGD SaT-156), B – dental in labial view (SMMGD SaT-172), C – epiphyal (SMMGD SaT-168), D – ceratohyal (SMMGD SaT-168), E – basiptyrgial (SMMGD SaT-413), F – vomer (SMMGD SaT-156).

on the secondary row. The latter tooth formula, which is very unusual in recent cyprinids, probably results from the attribution of inoperable tooth germs to the dentition (see her description and figure 1970: Abb. 8).

The tooth morphology corresponds to a generalized type. The neck of the tooth is hardly separated from the tooth crown; a pronounced hook is well developed. The hook is most strongly bent in the anterior teeth. Morphologically distinct “masticate” planes or edges are not developed.

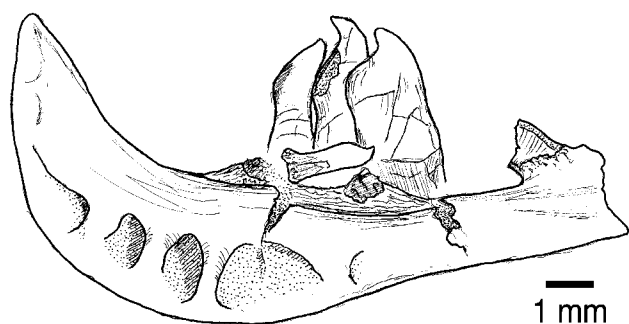

Text-fig. 9. *Protothymallus elongatus* (KRAMBERGER, 1885): Pharyngeal bone (medial view) with attached teeth (SMMGD SaT-620).

Opercle (text-fig. 5): The opercle shows a posterodorsal edge.

Cranial sensory organs (text-fig. 3, 5): The supraorbital canal (CSO) shows a particular course. It splits close to the sphenotic in two branches. The median branch does not reach the parietal and ends on the frontal near the triangle frontal-parietal-sphenotic. The lateral branch crosses the sphenotic to the pterotic and then parallels the infraorbital canal (CIO). A CSO-CIO connection can be detected in one of the three specimens examined (UL-V3)⁵ in which the lateral (main) branch of the CSO connects within the sphenotic to the CIO (Text-fig. 3). In both of the other cases the canals run virtually parallel. In a few specimens both components of the branch of the CSO are reduced. The median branch can be reduced (Text-fig. 5) or even absent. The lateral branch can also be reduced within the pterotic, but the sphenotic is regularly passed. The number of sensory canal openings on the CSO is maximally 10 (excluding the openings on the nasal). The number of openings on the CIO cannot be determined precisely.

The praeoperculo-mandibular canal (CPM) is not reduced at the end, i.e. a canal segment is present within the anterodorsal process of the operculum (#10-0, #34-0; Text-fig. 5). The CPM is interrupted in the anterior part along the articular. A connection between CPM and CIO is difficult to detect because this canal portion mostly runs within the skin and not within a bone or a bony tube (an exception occurs in *Tribolodon*, Phoxininae, where, according to Bogutskaya, 1990, a secondary connection of both canals through a bony tube – suprapraeopercular 2 – exists). The number of canal openings on the CPM is up to 14 (dentary 3 to 5, praeopercle 7, opercle 2).

The supratemporal canal (CST) does not cross the supraoccipital (#30-0, text-fig. 3). The canal is medially interrupted and shows 6 openings.

Weberian apparatus (text-fig. 10): The centres of the second and third vertebra are fused (#19-0). The neural complex (the unified neural spine of the third and second vertebra, which usually articulate with the neural arch of the second/composed and fourth vertebra) is dorsally split (#11-1). The occurrence of a lateral (= transversal) process at the neural arch of the third vertebra cannot be confirmed because of the preservation state (#1-?). The neural spine of the fourth vertebra is smaller than in the following ones. The first (free) supraneural has no contact with the neural complex (#12-0). The articulation head of the first pleural rib (on the fifth vertebra) is smaller than on the following ones. This rib is frequently preserved with the convex site forward, probably indicating a more horizontal articulation at the parapophysis, enabling more (sideward) mobility for this rib (#5-1; Cavender and Coburn 1992: 303). The air-bladder is not encapsulated (#31-0).

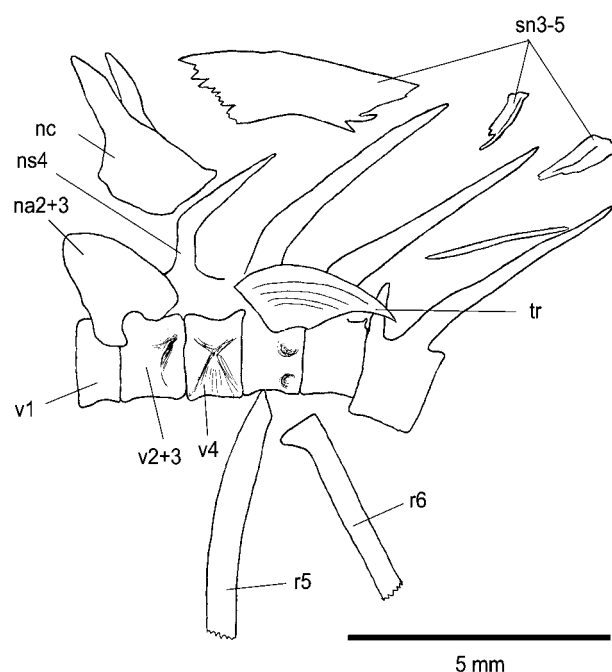

Text-fig. 10. *Protothymallus elongatus* (KRAMBERGER, 1885): Weberian apparatus (UL- V3).

Axial skeleton: The total number of vertebrae is 40 to 41 (vt 40[41]) (#39-0); the number of abdominal vertebrae is usually 23 and sometimes 24; these significantly exceed the number of postabdominal vertebrae, which is usually 17 and rarely 16 or 18 [av 23(24), $\bar{\Delta}$ av=23.16 (n=19); pav (16)17(18), $\bar{\Delta}$ pav= 17.00 (n=27); $\bar{\Delta}$ av- $\bar{\Delta}$ pav = 6.16] (#40-0). The number of abdominal non rib-bearing vertebrae is 2 to 3, rarely 4; that of the praedorsal vertebrae is 12 (e.g. the anterior dorsal pterygiophore is inserted between the 12th and 13th abdominal vertebrae) (#41-0). Praeanal vertebrae (postabdominal vertebrae before the insertion of the anterior ventral pterygiophore) are not developed (#42-0). The formula of the vertebrae column is: 4/16–17/2–3(4)/(16)17(18). The supporting skeleton of the caudal fin comprises rarely 5, usually 6 hypurals, 1 epural and 2 urals. The haemal and neural arcs of the praeural centra 2 and 3 can sometimes be doubled.

⁵ A disconnection between CSO and CIO (through reduction of the lateral and elongation of the medial branch of the CSO) is an apomorphic character state of the Leuciscinae and Phoxininae (Cavender and Coburn, 1992). CSO with both components of the branch, as in *Protothymallus*, represents the plesiomorphic character state.

Paired extremities (text-figs. 5, 8E): The supracleithrum is long, with a very small, stick-like posterior part. The posteroventral edge of the cleithrum is rounded. The postcleithrum is long. The coracoid is much reduced. Its anterior end is pointed (#21-1). A foramen between coracoid and cleithrum is absent (#22-1). The lateral and median processes of the deeply divided pelvic bone (basipterygial) lie in one plain (#9-0). The ventral fin, which is inserted shortly behind the dorsal fin, usually has 7 [2/(6)7], the pectoral fin 13 to 14 segmented and divided fin rays [2/(12)13-14(15)]. Sexual dimorphism regarding the form of the second undivided ventral fin ray is absent.

Unpaired extremities: The insertion of the dorsal fin lies above or slightly behind the ventral fin (#6-1). The dorsal fin comprises 3 (rarely 2) undivided fin rays (#14-1). The first ray is very small, not modified, and not separated from the second. The number of divided and segmented fin rays of the dorsal fin is 7 (rarely 8) [D (2)3/7(8)]. The number of dorsal pterygiophores is 8 or rarely 9. The anal fin bears 6 divided and segmented fin rays [A (2)3/6] (#24-1); the number of ventral pterygiophores is 7. The posterior border of the anal fin is slightly rounded. The first ventral pterygiophore is inserted on the first postabdominal (haemal) vertebra (#7-1). Serrated undivided fin rays occur neither in the dorsal fin nor in the anal fin.

Scales (text-fig. 11): Only in the late adult stage is the body completely covered with scales, i.e. only the largest specimens (>100 mm SL) show scales. In younger (smaller) individuals, scales are very thin and difficult to detect. The shape of the scales is round to oval, the basilateral corners are reduced. Important features are the absence of basal radii (#18-1) and apical circuli (#23-1; #25-1). A maximum of 20 caudal radii (= apical radii) are present; they are convergent, i.e. they run approximately parallel and do not originate from a common nucleus.

The lateral line (only seen in few specimens) is nearly straight (only slightly ventrally bent) and incomplete; it ends above the ventral fin. The lateral line seems to be completely absent in some specimens. Only a single juvenile specimen (pl. 2) shows sufficient preservation. 8 pierced scales can be counted along the lateral line (#17-0), i.e. only every second or third scale bears an opening for the sensory canal. The number of the scales along the median longitudinal scale row is relatively high, with more than 50 and up to 70 scales (LR > 50 to 70).

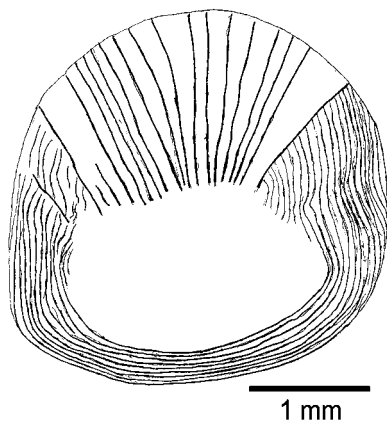

Text-fig. 11. *Protothymallus elongatus* (KRAMBERGER, 1885): scale from the Caudale peduncle (SMMGD SaTI61) .

Comparison with other Oligocene cyprinids

Some specimens from the localities studied in this paper were included in the genus *Chondrostoma* by Kramberger (1885) and Laube (1901). The osteology of this recent genus was revised by Bogutskaya (1997), according to whom the following features of *Protothymallus elongatus* are inconsistent with an allocation to *Chondrostoma*: small number of non rib-bearing abdominal vertebrae, almost triangular outline of the neurocranium, stretched and long dentary and maxilla, presence of a dorsomedial foramen on the dentary, presence of a prominent processus ascendens on the praemaxilla, broad interorbital part of the parasphenoid, course and formation of the CSO, reduced number of rays in the anal fin.

Furthermore, *Protothymallus elongatus* is distinct from the type of *Varhostichthys brevis* (AGASSIZ) from Valeč (Waltzsch, Böhme unpublished), mainly by the morphology, size, and robustness of the scales. In *V. brevis* the scale number along the mid-longitudinal row is 35, which is about the half that in *P. elongatus*. In addition, the scales of *V. brevis* have basal radii and numerous caudal radii (up to 50) that converge in the nucleus. Further differences are present in the morphology of the dentary, the dimensions and proportions of the body, the formula of the vertebrae, and in the number of anal fin rays. The dentary of *V. brevis* is less elongated. The largest of the three known specimens of *V. brevis* reaches 250 mm SL (330 mm TL), about twice as large as adult *P. elongatus* specimens. The body of *V. brevis* is compact in contrast to the elongated *P. elongatus*. The maximum body height of *V. brevis* is 42% of the SL, contrary to 24 to 27% SL in *P. elongatus*. The number of abdominal vertebrae in *V. brevis* is smaller (av 22-23, $\bar{\varnothing}_{av}=22.67$; n=3), and the number of postabdominal vertebrae slightly larger (pav 17-18, $\bar{\varnothing}_{pav}=17.33$; n=3) than in *P. elongatus* [av 23(24), $\bar{\varnothing}_{av}=23.16$, n=19; pav (16)17(18), $\bar{\varnothing}_{pav}=17.00$, n=27]. The number of the divided and segmented fin rays of the anal fin is generally 6 in *P. elongatus*, whereas it is 5 (one specimen) or 6 (two specimens) in *V. brevis*. These characteristics show clearly that both taxa can be distinguished, and that *Varhostichthys brevis* (AGASSIZ) is not a synonym of *Protothymallus elongatus* (KRAMBERGER), as was suggested by Gaudant (1996).

The comparison of *P. elongatus* to other Oligocene cyprinids, such as the genus *Palaeorutilus* (*P. colei* (v. MEYER, 1848), *P. primigenius* (GAUDANT, 1977), *P. medius* (REUSS, 1844), *P. papyraceus* (BRONN, 1828), *P. minor* (BÖHME, 1996), *P. enspelensis* (BÖHME, 1996)), *Tarsichthys* (= *Palaeotinca*) *macrurus* (AGASSIZ, 1834) and “*Leuciscus gloriosus*” TROSCHER, 1854, gives the following results.

The genus *Palaeorutilus* can be distinguished from *Protothymallus elongatus* by the following characteristics (for details see Böhme 2000): mouth inferior or subinferior; dentary without ventral lamina; maxilla without ventral lamina and with narrow dental process; reduced praeoperculo-mandibular canal (no segment of the canal on opercle); supraorbital canal not branched and not running from the sphenotic to the pterotic; sphenotic not extending to the roof of the cranium (e.g. contact between frontal and pterotic exists); narrow interorbital part of the parasphenoid; first circumorbital not elongated; orbital opening round; opercle

without posterodorsal edge; morphology of the pharyngeal teeth (presence of a “masticate” plane and a serrated lateral edge); fewer vertebrae (35–38) due to a reduced number of abdominal vertebrae (16–20); a larger number of divided and segmented fin rays in the anal fin (7–10); and the presence of only five hypurals.

Tarsichthys macrurus is characterized by the following features (Böhme unpublished): pronounced sexual dimorphism in the form of the second undivided ventral fin ray; fewer abdominal vertebrae (20), and fewer total vertebrae (36–37); more divided and segmented fin rays in the dorsal (8–9), anal (7–8), ventral (7–9) and pectoral fins (13–16); different morphology of the neurocranium, supraethmoid, dentary, hyomandibula, ceratohyal, pelvic bone, and scales.

Leuciscus gloriosus was erected by Troschel (1854) for a specimen from Rott. The publication was given without any description. In consequence, the name is a nomen nudum. This specimen (together with other fossils from Rott, e.g. the nomina nuda “*Leuciscus eurystomus*”, “*L. remotus*” and “*L. plesiopterus*” – all from Troschel 1861) can be distinguished from *Tarsichthys macrurus* (the common medium-sized cyprinid from Rott) as a different genus and species (Böhme unpublished; contrary to Gaudant, 2002). Therefore the name is here informally used in quotation marks. In contrast to *P. elongatus*, “*Leuciscus gloriosus*” shows a compact body, and differences in dentary morphology, hyomandibula, opercle, cleithrum and scales. Based on these characteristics, “*Leuciscus gloriosus*” is most likely related to *Varhostichthys brevis*.

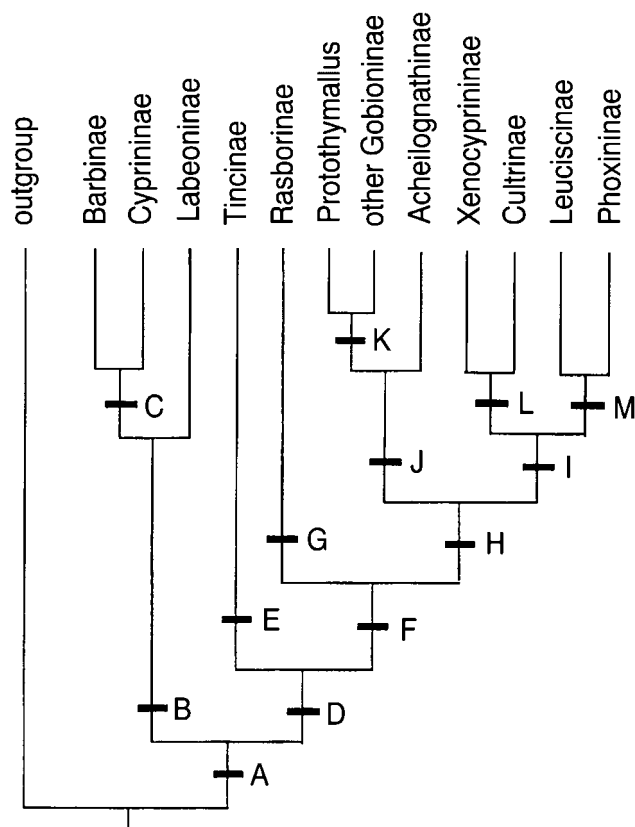

Text-fig. 12. Cladogram showing the systematic position of *Protothymallus* within the Cyprinidae (for the character states see Tab. 1).

Phylogenetic relationships of *Protothymallus*

The analysis of phylogenetic relationships was done according to the method of Cavender and Coburn (1992). *Protothymallus elongatus* belongs to the subfamily Gobioninae (text-fig. 12) based on the combination of the following synapomorphies (the numbers correspond to the character states in Table 1):

#4 – ventral boarder of the maxilla sigmoidally curved and distally inclined; #11 – crest of the neural complex dorsally divided; #13 – interorbital septum formed only by the orbitosphenoid; #14 – three undivided dorsal fin rays; #18 – scales without basal radii; #21 – coracoid reduced (shortened) and anteriorly pointed; #22 – loss of the fenestra between coracoid and cleithrum; #23 – scales with many apical radii, loss or modification of the apical circuli, reduction of the laterobasal corners; #24 – anal fin with 6 divided fin rays; #25 – scales without apical circuli.

The coding of the character states within the Gobioninae follows the interpretations of Ramaswami (1955) and Naseka (1996) (numbers of the character states continuing from Table 1).

26) Second praethmoid cartilage: not elongated (0), strongly elongated (1).

27) Kinethmoid: cylindrical (0), not cylindrical (1).

28) Ventral inflection of the anterior part of the vomer: absent (0), present (1).

29) Neurocranial fontanel absent (0), fontanel posterior between parietal and supraoccipital (1), anterior fontanel between supraethmoid and frontal, and posterior fontanel between frontal and parietal (2), only posterior fontanel (3).

30) Supratemporal sensory canal (CST): only along parietal (0), along parietal and supraoccipital (1).

31) Air bladder: free (0), nemachilin encapsulated (1), not nemachilin encapsulated (2).

32) Anteromedian process of supraethmoid: absent (0), strong (1).

33) Lacrimal process of palatine: short (0), long (1).

34) Opercle sensory canal-segment: present (0), reduced (1).

35) Rostral process of praemaxilla: short (0), large (1).

36) Mouth: terminal position (0), lower position (1), upper position (2).

37) Lower position of the mouth: through shortening of the lower jaw, without stretching the profile of the abdomen (1); without shortening of the lower jaw, but stretching the profile of the abdomen (2).

38) Pharyngeal teeth: having two rows (0), having one row (1).

39) Total number of vertebrae: low, 37–41 (0), high, 46–55 (1).

40) Number of abdominal vertebrae: higher than postabdominal vertebrae (0), lower than postabdominal vertebrae (1).

41) Number of praedorsal vertebrae: high, 11–13 (0), low 8–11(13) (1).

42) Praeanal vertebrae: absent (0), present (1).

Protothymallus lacks unambiguous apomorphies within the Gobioninae. Through some plesiomorphic character sta-

Tab. 1: Synapomorphies of the subfamilies of the Cyprinidae (according Cavender and Coburn, 1992). The labels of the nodes correspond to Text-fig. 12.

node	taxon	synapomorphies
B	Cyprinini	<ul style="list-style-type: none"> – (1) loss of the lateral process at the third neural arch – (2) presence of a frontal-sphenotic foramen – (3) supraethmoid with a rostral process – (4) ventral boarder of the maxilla sigmoidally curved and distally inclined
D	Leuciscini	<ul style="list-style-type: none"> – (5) head of the rib and parapophysis of the fifth vertebra modified for more mobility – (6) start of the dorsal fin behind the insertion of the ventral fin – (7) anteriorly shifted position of the anal fin, the first ventral pterygophore inserts at the first haemal process – (8) loss of rostral barbel and the associated maxillar foramen
E	Tincinae	<ul style="list-style-type: none"> – (9) tips of the divided pelvis bone side by side rested – (10) loss of the connection between praeoperculo-mandibular and temporal canal, loss of the opercle canal segment
F	Leuciscini without Tincinae	<ul style="list-style-type: none"> – (11) crest of the neural complex dorsally divided – (12) anterior (free) supraneural in contact with the neural complex – (13) interorbital septum formed only by orbitosphenoid – (14) three undivided dorsal fin rays
G	Rasborinae	<ul style="list-style-type: none"> – (15) anterior opening of the trigemino-facial chamber within the prootic – (16) contact between supraorbital and fifth circumorbital – (17) complete lateral line running in the lower half of the caudal peduncle
H	Leuciscini without Tincinae + Rasborinae	<ul style="list-style-type: none"> – (18) scales without basal radii
I	Xenocyprininae + Cultrinae + Leuciscinae + Phoxininae	<ul style="list-style-type: none"> – (19) centre of the second and third vertebra separated – (20) pterotic elongated, the anterior end reaches the height of the anterior opening of the trigemino-facial chamber
J	Gobioninae + Acheilognathinae	<ul style="list-style-type: none"> – (21) coracoid reduced (shortened) and anteriorly pointed – (22) loss of the fenestra between coracoid and cleithrum – (23) scales with many apical radii, loss or modification of the apical circuli, reduction of the laterobasal corners
K	Gobioninae	<ul style="list-style-type: none"> – (4) ventral boarder of the maxilla sigmoidal curved and distally inclined – (24) anal fin with 6 divided fin rays – (25) scales without apical circuli

tes, the genus is positioned next to *Gnathopogon* at the base of the Gobioninae (text-fig. 13). The generalized type of *Protothymallus* appears especially clear in the axial skeleton. According to Naseka (1996), the Gobioninae (gudgeons) can be divided into five groups based on the structure of the vertebral column (text-fig. 14). Four derived groups of benthic gudgeons and one “primitive” group of pelagic gudgeons. The latter are characterized by a low number of vertebrae, more abdominal than postabdominal vertebrae, a high number of praedorsal vertebrae, an absence of praeanal vertebrae, a low number of intermediate vertebrae, and a short distance between dorsal and anal fins. These character states are seen in *Protothymallus*, therefore this Oligocene genus belongs to the “primitive” group of Gobioninae (sensu Naseka, 1996), as do the recent genera *Gnathopogon*, *Pseudorasbora*, *Pungtungia* and *Pseudopungtungia*. The preferred environment of *Protothymallus* was consequently the middle of the water column.

The feeding mode of *Protothymallus*

An elongated lacrimal stabilizes the head of the maxilla and suppresses the lateral components of the maxilla move-

ment (according to Gosline and Smith and Bailey cit. in Micklich, 1985: 65). It attenuates the lateral extension of the foremost oropharynx, optimising the organism’s ability to suck up material (the motion of the maxilla in one plane) and reducing the maximum size of prey. *Protothymallus* reaches a lacrimal length of 24% L bas.n., which should be considered as elongate. The lacrimal of *Tinca tinca* (zoobenthophagous) and *Barbus barbuis* (omnivorous), both having an efficient sucking mechanism, reach 26% L bas.n., whereas in the (macro-)phytophagous *Ctenopharyngodon idella* (Valenciennes 1844) the length of the lacrimal is only 20% L bas.n.

Obrhelová (1970) interpreted a compact, dorsoventrally broadened ceratohyal as a feature of the increased activity of the hyoid arc (sucking intensity in capturing prey). The L/W-index of *Protothymallus* is 1.5 (maximum width measured at the facies epihyalis), indicating a strong muscular system of the hyoid (sternohyoid muscle). *Cyprinus carpio* LINNAEUS, 1758 (L/W-index 1.4) and *Tinca tinca* (LINNAEUS, 1758) (L/W-index 1.5) show similar compact ceratohyals, in contrast to *Squalius cephalus* (LINNAEUS, 1758) (L/W-index 1.65; Obrhelová, 1970: fig. 34c) and *Aspius aspius* LINNAEUS, 1758 (L/W-index 1.8; Obrhelová,

⁶ All measurements and data in this section are based, if not otherwise stated, on skeletons from the author’s private collection

Sacrocheilichthini

Gobionini

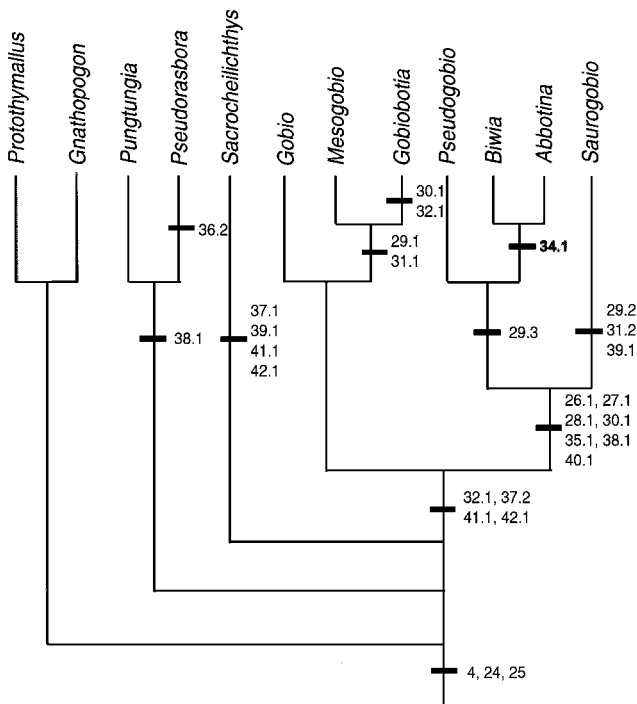

Text-fig. 13: Cladogram showing the systematic position of *Protothymallus* within the Gobioninae, (for the character states see Tab. 1 and text).

1967: fig. 24c), which have slender ceratohyals. This indicates that the sucking mechanism is less efficient for the latter two species (adult *S. cephalus* are facultative piscivorous and *A. aspis* piscivorous).

In *Protothymallus* the articulation of the hyomandibula is more vertically directed due to the relatively backward position of the articulation between the articular and quadratum (below the anterior third of the orbita), showing an obtuse angle (70°) between the praeopercular ridge and the plane of the cranial condyles. This construction allows the length of the hyomandibula to optimally enlarge the volume of the oropharynx (Micklich 1985: 117). This ability to enlarge the volume of the buccal space was probably very efficient in *Protothymallus* due to the coincidence of both factors (long hyomandibula – 46–50% L bas. n., large angle between praeopercular ridge and the plane of the condyles). The enlargement of the buccal space within species with a pronounced sucking mechanism is mostly caused by the length of the hyomandibula. The present author measured a length of 58% in *Rutilus rutilus* (LINNAEUS, 1758) (zoobenthophagous), 51% in *Tinca tinca*, and 50% in *Ctenopharyngodon idella* (L bas. n.). The high values in these three species are contrasted by relatively acute angles between the praeopercular ridge and the plane of the condyles: *R. rutilus* 40°, *T. tinca* 52° and *C. idella* 50°. Concerning Leuciscini without a specialized sucking mechanism, like the piscivorous *Aspius* and *Aspiolucius*, Bogutskaya (1994) mentioned a hyomandibula length of 30–42% and 27% L bas. n. respectively, but 40–54% L bas. n. for the diverse and differently adapted genus *Leuciscus*.

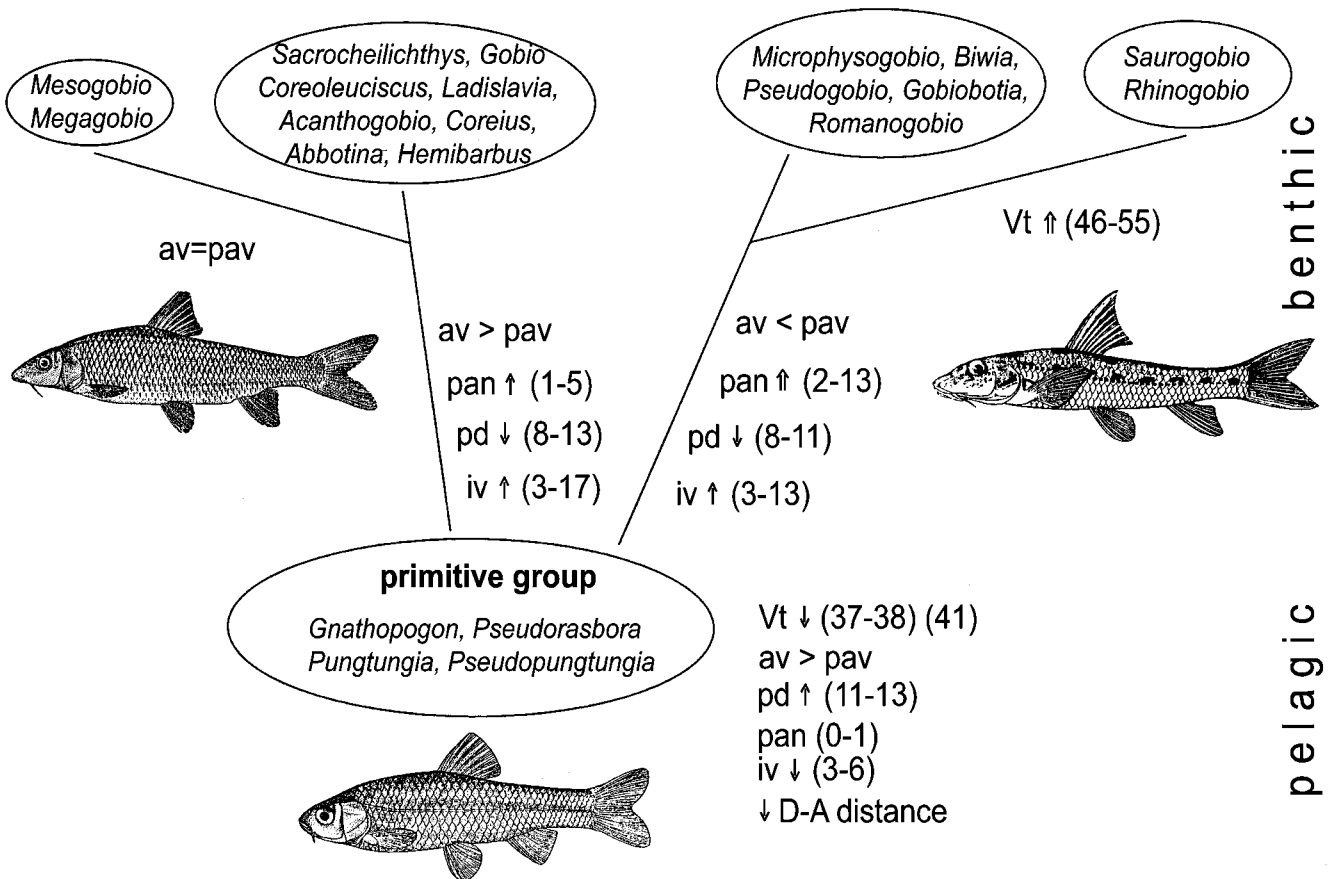

Text-fig. 14: Classification of the Gobioninae according to Naseka (1996).

Tab. 2: Eocene and Oligocene localities of Northern Bohemia and Southeast Saxony and their ectothermic vertebrate fauna. Taxa with an asterisk are proofed or determined by the author, others are according to literature. Radiometric (K-Ar) ages are from Bellon et al. 1998 (except for Dětaň, Mikuláš et al. 2003) and represent minimum ages which are measured on overlying lava flows.

	locality	fishes	amphibians	reptiles	reference
Late Oligocene	Kleinsaubernitz	<i>Palaeorutilus</i> aff. <i>medius</i> *			Böhme 1996
	Lužice-Žichov	<i>Palaeorutilus medius</i> *	<i>Triturus opalinus</i> , <i>Rana luschitzana</i> , <i>Asphaerion reussi</i>		Špínar 1972, Böhme 1996
	Suletice 19.8 ± 0.5 Ma		<i>Archaeotriton basalticus</i> , <i>Palaeobatrachus grandipes</i> , <i>P. laubei</i>		Špínar 1972, Böhme 1998
	Bechlejovice 24.5 ± 1.2 Ma	<i>Umbra prochazkai</i> *, <i>Pirskenius</i> sp.	<i>Archaeotriton basalticus</i> , <i>Palaeobatrachus diluvianus</i> , <i>P. luedeckei</i> , <i>P. rostae</i> , <i>P. grandipes</i> , <i>P. novotnyi</i> , <i>Eopelobates bayeri</i>	<i>Diplocynodon</i> sp.	Špínar 1972, Obrhelová and Obrhel 1987
Early Oligocene	Knížecí (Hrazený Hill) 29.5 ± 1.5 Ma	<i>Protothymallus</i> sp., <i>Pirskenius diatomaceus</i>			Obrhelová 1961
	Skalice (430 – 440 m NN; Einsiedelei)	<i>Protothymallus elongatus</i> *			Böhme this paper
	Lbín (435 m NN; W Mühlhäusel) 30.1 ± 0.7 Ma	<i>Protothymallus elongatus</i> *			Böhme this paper
	Hlinná (420 – 440 m NN)	<i>Protothymallus elongatus</i> *			Böhme this paper
	Seifhennersdorf-Varnsdorf 30.7 ± 0.7 Ma	<i>Protothymallus elongatus</i> *, Eleotridae indet.*	<i>Archaeotriton basalticus</i> *, <i>Palaeobatrachus diluvianus</i> , <i>P. grandipes</i> , cf. <i>Eopelobates</i> sp.	Crocodylia indet.*	Špínar 1972, Gaudant 1997, Böhme 1998 this paper
	Kundratice (Jesuit Valley) 32.7 ± 0.8 Ma	<i>Protothymallus elongatus</i> *	<i>Palaeobatrachus</i> sp.*, cf. <i>Eopelobates</i> sp.		Gaudant 1997, Böhme this paper
	Lukavice (MP 22 according to mammals)			<i>Diplocynodon</i> sp.	Laube 1901
	Markvartice (MP 22 according to mammals)	<i>Palaeorutilus</i> cf. <i>papyraceus</i> , <i>Varhostichthys</i> sp.	<i>Chelotriton laticeps</i> nov. comb.*, <i>Palaeobatrachus diluvianus</i> , <i>P. luedeckei</i> , <i>P. sp.</i>		Špínar 1972, Böhme 1996
	Valeč (MP 21 according to mammals)	<i>Palaeorutilus colei</i> *, <i>Varhostichthys brevis</i> *, <i>Esox waltschanus</i> *			Böhme 1996
Dětaň (MP 21 according to mammals) 32.6 ± 1.7 Ma		Salamandridae indet.*, <i>Palaeobatrachidae</i> indet.*, <i>Pelobatidae</i> indet.*, <i>Discoglossidae</i> indet.*	Lacertidae indet. 1*, Lacertidae indet. 2*, Anguidae indet.*, Testudinidae indet.*, Serpentes indet., Crocodylia indet.	Mikuláš et al. 2003, Fejfar and Kaiser 2005, Böhme this paper	
Late Eocene	Roudníky (drilling Ru 60, depth 30.6–31.4 m) 35.4 ± 0.9 Ma	<i>Cyclurus</i> sp., Umbridae indet.		<i>Diplocynodon</i> sp.	Bellon et al. 1998, Kvaček and Walther 2003

	locality	fishes	amphibians	reptiles	reference
Late Eocene	Kundratice (drilling KU-1, 368 m NN)	<i>Properca bispinella</i>			Obrhelová 1976
	Kostomlaty	<i>Cyclurus</i> sp., <i>Thaumaturus</i> sp.			Obrhelová and Obrhel 1987
	Kučlin 38.3 ± 0.9 Ma	<i>Cyclurus macrocephalus</i> *, <i>Thaumaturus furcatus</i> *, <i>Properca prisca</i> *, <i>Morone</i> sp.*	<i>Anura</i> indet.* (non <i>Palaeobatrachus</i>)	<i>Trionyx</i> sp., <i>Diplocynodon</i> sp.*	Obrhelová 1971, Gaudant 1996, Micklich and Böhme 1997

The elongate lacrimal suppressed lateral extensibility of the oropharynx and the possibility for significant enlargement of the buccal volume seen in *Protothymallus elongatus* indicate a particularly effective sucking mechanism, and therefore a probable zoobenthophagous or omnivorous feeding mode.

The vertebrates of the Seifhennersdorf and Varnsdorf localities: implications for lake ecology and palaeoclimate

Fishes

Represented by 101 collected skeletons, *Protothymallus elongatus* is by far the most abundant vertebrate of the Seifhennersdorf and Varnsdorf localities. Aside from this species, a second fish taxon found in the SMMGD collection is known only by a dozen specimens of disarticulated skeletons from Seifhennersdorf. A preliminary examination indicates that this material belongs to a small-sized (up to 4 cm TL) member of the family Eleotridae, the sleeper gobies, due to the palatopterygioid morphology (e.g. the presence of an entopterygioid = mesopterygioid). A detailed investigation will reveal whether it belongs to “*Lepidocottus*” *gracilis* as described by Laube (1901) from Varnsdorf. If this is found to be so, then “*Lepidocottus*” *gracilis* does not belong to the genus *Gobius* and it is not a synonym of *Pirskenius diatomaceus* OBRHELOVÁ, 1961, as suggested by Gaudant (1996). Some morphologic details (e.g. in the premaxilla and parasphenoid) indicate that the eleotrids from Seifhennersdorf differ from *Pirskenius diatomaceus* from Knížecí, which therefore remains a valid species.

European eleotrids are so far known only from otolith material (Böhme and Ilg, 2003). The oldest specimens come from the Early Oligocene (late Rupelian) of Romania (Reichenbacher and Codrea, 1999), while the youngest are from the Early Miocene (early Aquitanian) of Switzerland (Reichenbacher and Weidmann 1992).

Interestingly, both the eleotrid and *Protothymallus elongatus* seem to have lived in different habitats. Whereas *Protothymallus* skeletons are found in articulate preservation in laminated diatomite, indicating deep-water (e.g. pelagial) conditions, eleotrids are found disarticulated in non-laminated diatomite or clay stone. Commonly, the sediment containing eleotrid bones is rich in the aquatic roots of water plants known as *Confervites debilis* (HEER, 1855). These indicate that the fishes lived in densely vegetated, shallow water, littoral conditions where bioturbation was intense. This is consistent with the ecology of recent fresh-

water eleotrids, the majority of which are benthic and prefer still water among aquatic vegetation (Jonna and Weinheimer, 2003).

Thus, based on the fish fauna we can reconstruct two facies types for the Seifhennersdorf-Varnsdorf caldera lake: I) a littoral facies of non-laminated diatomite and clay stones with disarticulated eleotrids and aquatic vegetation; and II) a deep pelagial facies with laminated diatomites and articulated *Protothymallus elongatus* skeletons.

Amphibians and reptiles

Amphibians are represented by frogs and newts. The frogs were studied by Špinar (1972), who identified two species of the genus *Palaeobatrachus* TSCHUDI, 1839: *P. diluvianus* (GOLDUSS, 1831) and *P. grandipes* (GIEBEL, 1851). It is believed that species of the genus *Palaeobatrachus* have a fully aquatic lifestyle, and thus are typical inhabitants of permanent lake conditions. In Seifhennersdorf, frog remains are found only in the lowermost (fifth) diatomite seam (personal communication, H. Walther 2007). Salamanders are represented by only one species, *Archaeotriton basalticus* (v. MEYER, 1859), the holotype (now lost) of which came from Varnsdorf. This newt is endemic to the Early Oligocene of northern Bohemia and Saxony (Böhme 1998). It shows a laterally strongly compressed tail, and is interpreted as having been an excellent swimmer of the littoral of lakes with oligotrophic and meromictic conditions (Böhme 1998, Böhme and Rössler 2002).

The presence of reptiles is demonstrated by a few undetermined remains of crocodiles (one coprolith and two bone fragments in the SMMGD collection) from Seifhennersdorf. Turtles are completely absent – an interesting and yet unexplained phenomenon, which is typical not only of the Seifhennersdorf-Varnsdorf lake, but of the entire Oligocene of the densely sampled volcano-detritic-complex of northeastern Bohemia and southeastern Saxony. The crocodile remains indicate at least subtropical temperatures, meaning annual temperatures above 14.2 °C and the temperature of the coldest month above 5.5 °C (Markwick 1998, Böhme 2003).

Synoptic overview about the Eocene and Oligocene ectothermic vertebrates of northern Bohemia and southeastern Saxony

The stratigraphy of the volcano-detritic complex in northern Bohemia and southeastern Saxony is based on radiometric dating, as well as faunal and floral changes

(Obrhelová and Obrhel 1987, Bellon et al. 1998, Kvaček and Walther 2003). Only a few localities have yielded fossil mammals that can be correlated to mammalian biostratigraphic units. These localities are Valeč and Dětaň (both in the Doupovské hory Mountain), and Markvartice and Lukavice (both in the České středohoří Mountains). The former two are interpreted to belong to MP 21 (earliest Oligocene; Fejfar and Storch 1994), whereas the latter two are attributed to MP 22 (Böhme 1996, Uhlig 1999). It should be noted, however, that the mammalian data are not sufficient for unambiguously distinguishing the MP-units. It seems that the chronostratigraphic subdivision of the Paleogene sequences is far from being robust and will be a matter of further research. The stratigraphy presented in Table 2 is therefore tentative.

Nevertheless, a clear subdivision is possible based on fish assemblages (Obrhelová and Obrhel 1987). The Eocene association is characterized by the genera *Cyclurus*, *Thaumaturus*, *Properca*, and *Morone*. Available radiometric dating from the Kučlín and Roudníky localities indicate ages for the oldest association between 35 and 39 Ma. A pronounced faunal change occurs around the Eocene-Oligocene boundary, characterized by the disappearance of all older elements and the appearance of the first Cyprinids (*Protothymallus*, *Varhostichthys*, *Palaeorutilus*) and Esocids (*Esox*). The most characteristic species is the gobioid cyprinid *Protothymallus elongatus*. This assemblage is locally associated with mammals indicating MP 21/22 “zones”, suggesting that this ichthyofaunal change could be contemporaneous with the mammalian *Grande Coupure*, probably predating 33 Ma. This fish association, which is accompanied by two of the oldest European gobioids (*Pirskenius* and eleotrids), seems to be characteristic for the entire Early Oligocene. In Late Oligocene associations, the genera *Protothymallus* and *Varhostichthys* are lacking, while a new species of *Palaeorutilus* (*P. medius*) seems to be characteristic.

The amphibian faunas are dominated by aquatic groups, especially by palaeobatrachids. Semi-aquatic salamanders like *Archaeotriton basalticus* or *Chelotriton laticeps* (nov. comb., Böhme in prep.) are rare, whereas semi-aquatic frogs like *Eopelobates* are mostly known only as tadpoles (Gaudant 1997). Amphibians and reptiles with more terrestrial lifestyles (e.g. *Salamandra*, *Latonia*, lizards) are absent. An exception is provided by a newly discovered fossiliferous lens in the Dětaň locality (Doupovské hory Mountains) that was intercalated in subaerial volcanic tuffs and interpreted as a termite colony (Fejfar and Kaiser 2005). In addition to small mammals and land snails, it contains highly fragmented amphibian and reptile bones identified here as Salamandridae indet., Palaeobatrachidae indet., Pelobatidae indet., Discoglossidae indet., Lacertidae indet. 1, Lacertidae indet. 2, and Anguidae indet. Their association with fragments of large land turtles (Testudinidae indet.), snakes and crocodiles within the tuffs of the classic bone-bearing layer in Dětaň (Fejfar 1987; Fejfar and Kaiser 2005), reflect local dry conditions in relatively open landscapes formed by volcanic eruptions, which is consistent with the conclusions of Mikuláš et al. (2003). Apart from this specific environmental condition at the base of the Doupov stratovolcano, dry adapted herpetofaunas are

unknown from the České středohoří Mountains. This is explained by the dominance of volcanic lakes in the environment of northeastern Bohemia and southeastern Saxony. The additional absence of aquatic turtles could probably be the result of unfavourable living conditions in these maar or caldera lakes.

Concluding remarks about the subfamily status of the Paleogene and early Neogene cyprinids in Europe

Northern Bohemia is the only European region with an approximately continuous record of freshwater fish faunas across the Eocene/Oligocene boundary (Tab. 2). As stated above, this period is characterized by an ichthyofaunal renewal involving the gradual disappearance of most typical Eocene taxa, such as amiids, lepidosteids (not present in Bohemia or Saxony), thaumatourids, percichthyids, and the first occurrence of cyprinids, esocids, gobioids, and cyprinodontids.

Within the cyprinids, three genera belonging to two subfamilies are known from the beginning of the Early Oligocene (MP 21–23), which thus represent the oldest European members of this family (Böhme 2000 and the present article): *Protothymallus* and *Varhostichthys* (Gobiioninae), and *Palaeorutilus* (Phoxininae). Later in the Early Oligocene (MP 24), the first representatives of tincins (*Tarsichthys* = *Palaeotınca*) appear (Schulz-Mirbach and Reichenbacher 2006). These three subfamilies characterized the Late Oligocene assemblages (Böhme in press), whereas leuciscins, which dominate the European freshwater fish fauna today, and cyprinins, appear in European waters during the Early Miocene (MN 3, Böhme 2000, Gaudant et al. 2002).

Acknowledgements

I want to express my gratitude to Harald Walther (Dresden) and Zlatko Kvaček (Prague) for the inspiration for undertaking this study, and for fruitful discussions. Many thanks to Waltraud Harre (Berlin) and Ms. Bastian (Dresden), who prepared the images of Plates 1 and 2, to Bettina Schenk (Munich) for the final arrangements of the figures, and to August Ilg (Düsseldorf) for help with the English style and grammar. I am also grateful to Bettina Reichenbacher (Munich) and an anonymous reviewer for improving the manuscript.

References

- Agassiz, L. (1833–43): Recherches sur les poissons fossiles. – Bd. I – V.; Neuchatel.
- Ahrens, H. (1957): Stratigraphisch-tektonische Untersuchungen im Tertiär von Seiffhennersdorf O.L. – Unpublished diplom thesis, Humboldt-University Berlin.
- Ahrens, H. (1959): Stratigraphisch-tektonische Untersuchungen im Tertiär von Seiffhennersdorf. – *Geologie*, 8: 340.
- Anđelković, J. S. (1970): Tertiary fishes of Serbia. – *Geoloski anali Balkanskog poluostrva*, 35: 281–365.
- Anđelković, J. S. (1989): Tertiary fishes of Yugoslavia. – *Palaeontologia Yugoslavica*, 38: 1–121.

- Bellon, H., Bůžek, C., Gaudant, J., Kvaček, Z., Walther, H. (1998): The České Středohoří magmatic complex in Northern Bohemia 40K-40Ar ages for volcanism and biostratigraphy of the Cenozoic freshwater formations. – *Newsletters on Stratigraphy*, 36 (2/3): 77–103.
- Bogutskaya, N.G. (1990): Morphology of cyprinid fishes of the subfamily Leuciscinae (Cyprinidae). Part 2. – *Voprosy Ichthyologii*, 30 (6): 920–933. (in Russ.)
- Bogutskaya, N. G. (1994): A description of *Leuciscus lepidus* (Heckel, 1843) with comments on *Leuciscus* and leuciscine – aspinine relationships. – *Annalen Naturhistorisches Museum Wien*, 96 B: 599–620.
- Bogutskaya, N.G. (1997): *Chondrostoma beysehirense*, a new cyprinid fish from Beysehir Lake, Central Turkey. – *Ichthyol. Explor. Freshwaters*, 8 (2): 151–158.
- Böhme, M. (1996): Revision der oligozänen und untermiozänen Vertreter der Gattung *Palaeoleuciscus* (Teleostei, Cyprinidae) Mitteleuropas. – Unpublished Thesis, University Leipzig: 109 pp., 43 figs, 7 tabs, 9 pls.
- Böhme, M. (1998): *Archaeotriton basalticus* (v. Meyer, 1859) (Urodela, Salamandridae) aus dem Unteroligozän von Hammerunterwiesenthal (Freistaat Sachsen). – *Abhandlungen des Staatlichen Museums für Mineralogie und Geologie zu Dresden*, 43/44 (1998): 265–280.
- Böhme, M. (2000): Die Cypriniden (Teleostei, Cypriniformes) des oberoligozänen Maares von Enspel nebst Bemerkungen zur Phylogenie und Biogeographie der Phoxininae. – *Paläontologische Zeitschrift*, 74 (1/2): 99–112.
- Böhme, M. (2003): Miocene Climatic Optimum: evidence from Lower Vertebrates of Central Europe. – *Palaeogeography, Palaeoclimatology, Palaeoecology*, 195 (3–4): 389 – 401.
- Böhme, M., Rössler, R. (2002): Fund eines zweiten Skelettes von *Archaeotriton basalticus* (Urodela, Salamandridae) aus dem Unter-Oligozänen Maar von Hammerunterwiesenthal (Erzgebirge). – *Veröffentlichungen des Museums für Naturkunde Chemnitz*, 25: 63–68.
- Böhme, M. and Ilg, A. (2003): fosFARbase. – Accessed March 12, 2007 at www.wahre-staerke.com/
- Bůžek, Č., Kvaček, Z., Walther, H. (1978): Tertiary floras from the surroundings of Kundratice in relation to the volcanic phases of the České Středohoří Mts. – *Věstník Ústředního ústavu geologického*, 53 (6): 347–356.
- Bůžek, Č., Fejfar, O., Konzalova, M., Kvaček, Z. (1990): Floristic changes around Stehlin's grande coupure in Central Europe. – *Proceedings of the Symposium "Paleofloristic and Paleoclimatic changes in the Cretaceous and Tertiary"*, 1989: 167–181.
- Cavender, T. M., Coburn, M. M. (1992): Phylogenetic relationships of North American Cyprinidae. – In: Mayden, L. (Ed.): *Systematics, historical ecology and North American freshwater fishes*. – Stanford University Press, pp. 293–327.
- Engelhardt, H. (1876): Tertiärpflanzen aus dem Leitmeritzer Mittelgebirge. Ein Beitrag zur Kenntnis der fossilen Pflanzen Böhmens. *Nova Acta Leop. Carol. Akademie der Naturforscher*, 38: 341–440.
- Engelhardt, H. (1882): Ueber die Flora des "Jesuitengrabens" bei Kundratitz im Leitmeritzer Mittelgebirge. – *Sitzungsberichte und Abhandlungen der naturwissenschaftlichen Gesellschaft Isis in Dresden*, 1882 (2): 13–18.
- Fejfar, O. (1987): A Lower Oligocene mammalian fauna from Detan and Dvorce NW Bohemia, Czechoslovakia. – *Münchner Geowissenschaftliche Abhandlungen*, A, 10: 253–264.
- Fejfar, O., Kaiser, T. (2005): Insect bone-modification and paleoecology of Oligocene mammal-bearing sites in the Doupov Mountains, Northern Bohemia. – *Palaeontologia Electronica* 8 (1); 8A:11p.
- Fejfar, O., Storch, G. (1994): Das Nagetier von Valeč-Waltsch in Böhmen – ein historischer fossiler Säugetierfund (Rodentia: Myoxidae). – *Münchner Geowissenschaftliche Abhandlungen*, A, 26:5–53.
- Gaudant, J. (1993): The Eocene freshwater fish-fauna of Europe: from palaeobiogeography to palaeoclimatology. – *Kaupia, Darmstädter Beiträge zur Naturgeschichte*, 3: 231–244.
- Gaudant, J. (1996): Rectifications de nomenclature relatives à l'ichthyofaune oligo-miocène dulcaquicoles de Bohême. – *Journal of the Czech Geological Society*, 41: 91–96.
- Gaudant, J. (1997): Cinq nouveaux gisements de Pelobatidae (Amphibiens anoures) dans l'Oligocène d'Europe centrale. – *Neues Jahrbuch für Geologie und Paläontologie, Monatshefte*, 1997: 434–446.
- Gaudant, J. (2002): New Investigations on the Fish Fauna of the Oligocene Lignitic Papershales from Rott, Stößchen am Minderberg et Orsberg (Siebengebirge, Germany). – *Palaeontographica*, A, 265: 121–177.
- Gaudant, J., Weidmann, M., Berger, J. P., Bolliger, T., Kálin, D., Reichenbacher, B. (2002): Recherches sur les dents pharyngiennes de Poissons Cyprinidae de la Molasse d'eau douce oligo-miocène de Suisse (USM, OSM) et de Haute-Savoie (France). – *Revue de Paléobiologie*, 21(1): 371–389.
- Giebel, C. G. (1857): Tertiäre Wirbeltierreste bei Zittau. – *Zeitschrift für die gesamten Naturwissenschaften*, pp. 315–317.
- Gorjanović-Kramberger, D. (1885): Paleoichthyološki priloz. – *Rad Jugoslavenske Akademije Znanosti i Umjetnosti*, 72: 10–66.
- Gorjanović-Kramberger, D. (1886): Palaeoichthyologische Beiträge. – *Glasnik Hrvatskoga naravoslovnoga društva*, 1: 123–137.
- Hein, L., Schwab, G. (1958): Über Verkieselungserscheinungen in der Braunkohle von Seifhennersdorf/Oberlausitz. – *Geologie*, 7 (8): 1020–1056; Berlin.
- Hibsch, J. E. (1926): Geologische Übersichtskarte des Böhmisches Mittelgebirges 1:100.000 mit Erläuterungen. – Tetschen.
- Hibsch, J. E., Seemann, F. (1913): Geologische Karte des Böhmisches Mittelgebirges, Blatt IX (Leitmeritz-Tribsch) nebst Erläuterungen. – 198 pp., A. Hölder, Wien.
- Hurník, S., Knobloch, E. (1966): Einige Ergebnisse paläontologischer und stratigraphischer Untersuchungen im böhmischen Tertiär. – *Abhandlungen des Staatlichen Museums für Mineralogie und Geologie zu Dresden*, 11: 17–161.
- Jokély, J. (1859): Der nordwestliche Theil des Riesengebirges und das Gebirge um Rumburg und Hainspach in Böhmen. – *Jahrbuch geologische Reichsanstalt Wien*, 10: 365.

- Jonna, R., Weinheimer, M. (2003): "Eleotridae" (On-line), Animal Diversity Web. Accessed March 12, 2007 at <http://animaldiversity.ummz.umich.edu/site/accounts/information/Eleotridae.html>.
- Knobloch, E., Konzalová, M., Kvaček, Z. (1996): Die obereozäne Flora der Stare Sedlo-Schichtenfolge in Böhmen (Mitteleuropa). – Rozpravy Československého geol. Úst., 49: 1–260.
- Kozalová, M. (1981): *Boehlensipollis* und andere Mikrofossilien des böhmischen Tertiärs (vulkanogene Schichtenfolge). – Sborník geol. věd., Paleont., 24: 135–162.
- Kopecký, L. (coord.) (1990): Vysvětlivky k základní geologické Mapě ČSSR 1:25.000. Nr. 02–341 Bílina: 1–112; Praha.
- Kvaček, Z. (2002): Late Eocene landscape, ecosystems and climate in northern Bohemia with particular reference to the locality Kučlín near Bílina. – Bulletin of the Czech Geological Survey, 77 (3): 217–236.
- Kvaček, Z., Walther, H. (1998): The Oligocene volcanic flora of Kundratice near Litoměřice, České Středohoří Volcanic Complex (Czech Republic) – a review. – Acta Musei Nationalis Pragae, B, 54 (1–2): 1–42.
- Kvaček, Z., Walther, H. (2003): Reconstruction of vegetation and landscape development during volcanic activity in the České Středohoří Mountains. – Geolines 15: 60–64.
- Laube, G. (1900): Salmoniden aus der böhmischen Braunkohleformation. – Sitzungsberichte des deutschen naturwissenschaftlich-medizinischen Vereines für Böhmen „Lotos“, N.F. 20: 15–20.
- Laube, G. C. (1901): Synopsis der Wirbelthierfauna der Böhm. Braunkohlenformation. – Abhandlungen des deutschen naturwissenschaftlich-medizinischen Vereines für Böhmen "Lotos", 2 (4): 107–186.
- Markwick, P. J. (1998): Crocodylian diversity in space and time: The role of climate change in paleoecology and its implication for understanding K/T extinctions. – Paleobiology, 24: 470–497.
- Menzel, P. (1898): Beitrag zur Kenntnis der Tertiärflora des Jesuitengrabens bei Kundratitz. – Abhandlungen der naturwissenschaftlichen Gesellschaft Isis in Dresden, 1897 (1): 18 pp.
- Meyer, H. v. (1860): Die Salamandriden aus der Braunkohle am Rhein und in Böhmen. – Palaeontographica, 7: 47–73.
- Micklich, N. (1985): Biologisch-paläontologische Untersuchungen zur Fischfauna der Messeler Ölschiefer (Mittel-Eozän, Lutetium). – Andrias, 4: 171 pp.
- Micklich, N. and Böhme, M. (1997): Wolfsbarsch-Funde (Perciformes, Moronidae) aus den Süßwasser-Diatomiten von Kučlín (Böhmen) nebst Anmerkungen zur taxonomischen Stellung von "*Perca*" *lepidota* aus den Süßwasserkalken von Öhningen (Baden). – Paläontologische Zeitschrift, 71(1/2): 117–128.
- Mikuláš, R., Fejfar, O., Ulrych, J., Žigová, A., Kadlecová, E., Cajz, V. (2003): A study of the Dětaň locality (Oligocene, Doupovské hory Mts. Volcanic Complex, Czech Republic): collection of field data and starting points for interpretation. – Geolines, 15: 91–97.
- Naseka, A. M. (1996): Comparative study on the vertebral column in the Gobioninae (Cyprinidae, Pisces) with special reference to its systematics. – Publ. Espec. Inst. Esp. Oceanogr. 21: 149–167.
- Obrhelová, N. (1961): Vergleichende Osteologie der tertiären Süßwasserfische Böhmens (Gobioidei). – Sborník Ústř. Úst. geol. paleont., 26: 103–192.
- Obrhelová, N. (1967): Cyprinoidei (Pisces) aus dem Hangenden des Miozänen Braunkohleflözes Nordböhmens. – Palaeontographica, 126A: 141–179.
- Obrhelová, N. (1969): Die Karpfenfische des Tschecoslovakischen Süßwassertertiär. – Časopis pro mineralogii a geologii, 14 (1): 39–52.
- Obrhelová, N. (1970): Osteologie der Vorläufer von *Tinca tinca* (Pisces) aus den Süßwassertertiär der ČSSR. – Abhandlungen des Staatlichen Museums für Mineralogie und Geologie zu Dresden, 16: 99–209.
- Obrhelová, N. (1971): Über einen Serranid (Pisces) aus dem nordböhmischen Süßwassertertiär. – Časopis pro mineralogii a geologii, 16 (4): 371–387.
- Obrhelová, N. (1976): Eine neue Percoiden-Art (Pisces) aus dem Nordböhmischen Süßwassertertiär. Bemerkungen zur Gattung *Bilinia* Obrhelová 1971. – Časopis pro mineralogii a geologii, 24: 135–146.
- Obrhelová, N. and Obrhel, J. (1987): Paläoichthyologie und Paläoökologie des kontinentalen Tertiärs und Quartärs in der ČSSR. – Zeitschrift für geologische Wissenschaften, 15 (6): 709–731.
- Patterson, C. (1984): Chanoides, a marine Eocene otophysan fish (Teleostei: Ostariophysi). – Journal of Vertebrate Paleontology, 4: 430–456.
- Procházka, M. (1955): Fytopaleontologický výzkum diatomitů Českého Středohoří. – Zpr. Geol. Výzk. V R. 1954: 141–143.
- Ramaswami, L. S. (1955): Skeleton of Cyprinoid fishes in relation to phylogenetic studies. 6. The skull and weberian apparatus in the subfamily Gobioninae (Cyprinidae). – Acta Zoologica, 36: 127–158.
- Reichenbacher, B., Codrea, V. (1999): Fresh- to brackish water fish faunas from continental Early Oligocene deposits in the Transylvanian Basin (Romania). – Bulletin de l'Institut Royal des Sciences Naturelles de Belgique, Science de la Terre, 69: 197–207.
- Reichenbacher, B., Weidmann, M. (1992): Fisch-Otolithen aus der oligo-/miozänen Molasse der West-Schweiz und der Haut-Savoie (Frankreich). – Stuttgarter Beiträge zur Naturkunde, Serie B 184: 1–83.
- Reuss, A. E. (1840): Die Umgebung von Teplitz und Bilin in Beziehung auf ihre geognostischen Verhältnisse. Ein Beitrag zur Physiognomie des böhmischen Mittelgebirges. – Prag, Leitmeritz und Teplitz.
- Schulz-Mirbach, T., Reichenbacher, B. (2006): Reconstruction of Oligocene and Neogene freshwater fish faunas – an actualistic study on cypriniform otoliths. – Acta Palaeontologica Polonica, 51 (2): 283–304.
- Špinar, Z. V. (1972): Tertiary frogs from Central Europe. – Academy of Science, Prague, 286 pp.
- Troschel, F.H. (1854): Über die fossilen Fische aus der Braunkohle des Siebengebirges. – Verhandlungen des naturhistorischen Vereines des preußischen Rheinlande und Westphalens, 11: 1–28.
- Troschel, F. H. (1861): [without title]. – Verhandlungen des naturhistorischen Vereines des preußischen Rheinlande und Westphalens, N. F. 8: 55–56.

- Uhlig, U. (1999): Die Rhinoceroidea (Mammalia) aus der unteroligozänen Spaltenfüllung Möhren 13 bei Treuchtlingen in Bayern. – Bayerische Akademie der Wissenschaften, Mathematisch-naturwissenschaftliche Klasse, Abhandlungen, Neue Folge, 254 pp.
- Walther, H. (1988): Museum Seifhennersdorf, Geologie, Paläontologie, Bergbau. – Second revised edition, Neugersdorf, 43 pp.
- Walther, H. (1996): Das Tertiär-Vorkommen von Seifhennersdorf (Oberlausitz, Deutschland). – Neues Jahrbuch für Geologie und Paläontologie, Abhandlungen, 200 (1/2): 5–26.
- Wolterstorff, W. (1886, 1887): Ueber fossile Frösche insbesondere das Genus *Palaeobatrachus*. – Teil 1 (1886) und 2 (1887); Magdeburg.