

Some oligopygoids of the genus *Haimea* Michelin (Echinoidea) from the Eocene of Cuba

Jiří Žítt

Geologický ústav AVČR, Rozvojová 135, 165 00 Praha 6, Česká republika



Žítt, J. (1994): Some oligopygoids of the genus *Haimea* Michelin (Echinoidea) from the Eocene of Cuba. Acta Mus. Nat. Pragae, 49B (1993) 1—4: 1—40, Praha

The study of the oligopygoid *Haimea* from a well-known Middle Eocene locality Loma Caoba near San Diego de los Baños, western Cuba, has shown only three species to be present. Most frequent is *H. alta* (ARNOLD et H. L. CLARK, 1927) (synonyms: *H. pentagona* SÁNCHEZ ROIG, 1953; *H. gigantea* SÁNCHEZ ROIG, 1953; *H. cylindrica* SÁNCHEZ ROIG, 1953 (non Arnold et H. L. Clark, 1927)). The other species, *H. subcylindrica* SÁNCHEZ ROIG, 1953 and *H. sp.* are relatively scarce. Thirty three various features were studied including the volume of test. No significant differences between the Cuban and the Jamaican specimens of *H. alta* were ascertained. *H. subcylindrica* is a member of a group of species distinguished by more or less circular and low tests: *H. ruttleri* (PIJPERS) from Bonaire, *H. meunieri* (LAMBERT) from Senegal, *H. lata* (ARNOLD et H. L. CLARK) from Jamaica. Macromorphologically the nearest to *H. subcylindrica* appears to be *H. lata*, but there is great difference in the structure of ambulacra beyond petals. *H. subcylindrica* has complex groups of small plates developed on adradial suture, while there are only simple demiplates in *H. lata*. Some abnormal specimens in all species were found; a partial hexamerous variant of *H. sp.* is of greatest interest.

In addition to the species from Loma Caoba the material of *H. ovumserpentis* (GUPPY) from Sánchez Roig's collection was revised. The work resulted in the description of *H. rojasi* sp. n. based on four specimens coming from three localities of probable Late Eocene age (Alcalá y Báguanos Holguín; Sancti Spiritus, Santa Clara; Finca La Rabona, Morón, Camagüey). The new species shows the most complex structure of ambulacra beyond the petals known up to date in *Haimea*.

INTRODUCTION

Oligopygoids were studied in detail by Kier (1967a), who ascertained that they are very promising for the stratigraphy of Middle and Upper Eocene strata. Geographically, they were known from the Caribbean region, from the southeastern United States, Mexico, northern South America and western Africa. The importance of oligopygoids, however, was greatly accentuated by their recent finds in Greece (Richter et Seibertz 1978). Kier's paper (op. cit.) included a large number of species belonging to *Haimea* and *Oligopygus*. A certain number of species (largely from Cuba), however, has remained unrevised, as the original specimens were not available to Kier. It is the aim of my present paper to add new information on some species of *Haimea* from Cuba, especially from the very rich and now even classical Sánchez Roig's Loma Caoba locality.

The rich material collected by me during 1974—1975 made it possible to select a sufficient number of relatively well preserved specimens, especially those of *Haimea alta*. The data concerning the locality, its

geographic situation etc. were published in my papers dealing with the other Cuban echinoids (see Žitt, 1981, 1985a, b).

At this locality only *Haimea* occurs (as in the entire region of Loma Caoba Hill) and no specimen of *Oligopygus* was found. The quantity of specimens is amazing. During two hours more than one thousand specimens were collected by three persons. *Haimea* is accompanied by many schizasterids [*Paraster clarki* SÁNCHEZ ROIG, *P. caobaense* (S. ROIG), *P. delgadoi* S. ROIG, *P. cf. bathypetalus* ARNOLD et H. L. CLARK, *Schizaster brachypetalus* ARNOLD et H. L. CLARK, *Agassizia caobaensis* S. ROIG, *Aguayoaster aguayoi* S. ROIG, a. o.], brissids [*Eupatagus (Eupatagus) caobaense* S. ROIG, *E. (E.) pinarensis* S. ROIG, *Meoma caobaensis* S. ROIG, a. o.] and other echinoids (see Sánchez Roig, 1949, 1952a, b, 1953a, b). Although many spatangoid specimens are deformed or fragmentary, *Haimea* proved to be relatively well preserved in shape owing to its very thick test walls.

The study of the species of *Haimea* from Loma Caoba was supplemented by a revision of Sánchez Roig's old material which was till now considered to represent the species *Haimea ovumserpentis* (GUPPY). The study of all Cuban species of *Haimea* confirmed the great taxonomic importance of ambulacra structure beyond the petals (demiplates, included plates, primary plates, see Kier op. cit.).

Acknowledgements

I think it is my pleasant duty to thank the management of the Geological and Palaeontological Institute of the Academy of Sciences of Cuba in Havana for ensuring my works in the field. My thanks are also due to the workers of the Paleontological collections and my friend Néstor Enríquez Salgueiro from the same Institute. I am very grateful to Mr. Kier from the Smithsonian Institution (Washington) for his kind help during my studies. I am also obliged to prof. V. Pokorný and J. Kulich of the Department of Palaeontology, Charles University, Prague, for enabling me the preparation of specimens on air-abrasive machine in their laboratory. I am indebted also to R. J. Prokop from the National Museum, Prague, for reading the manuscript.

LIST OF MEASUREMENTS

All measurements (some of them see text — fig. 1) and counts used for practical reasons in this paper were designated with numbers (1–34). In this way a brief and simple reference (e.g. in tables and scatter-diagrams) was enabled. These numbers are as follows:

1 — length of test (=L); 2 — width of test; 3 — maximum height of test; 4 — distance of apical system center from anterior margin of test; 5 — length of petal II (IV); 6 — length of petal I (V); 7 — length of petal III; 8 — distance of distal ends of petals II and IV; 9 — the same in petals I and V; 10 — distance of line joining distal ends of petals I and V from posterior margin of test; 11 — distance of line joining distal ends of petals II and IV from anterior margin of test; 12 — maximum width of petal II (IV); 13 — ditto of petal I (V); 14 — ditto of petal III; 15 — width of interporiferous zone of petal II (IV); 16 — ditto of petal I (V); 17 — ditto of petal III; 18 — number of porepairs in one zone of petal II (IV); 19 — ditto of petal I (V); 20 — ditto of petal III; 21 — number of pores in one zone beyond petal II (IV); 22 — ditto beyond petal I (V); 23 — ditto beyond petal III; 24 — number of primary plates beyond petal II (IV); 25 — ditto beyond petal I (V); 26 — ditto beyond petal III; 27 — number of plates in 1 (4); 28 — ditto in 2 (3); 29 — ditto in 5; 30 — distance of aboral periproct margin from posterior margin of test; 31 — transverse diameter of periproct; 32 — angle made by petal II (IV) and plane of symmetry (measured anteriorly); 33 — angle made by petal I (V) and plane of symmetry (measured posteriorly); 34 — volume of test.

Values 1 to 17, 30 and 31 were measured in millimeters, number 32 and 33 in angle degrees, and number 34 in millilitres.

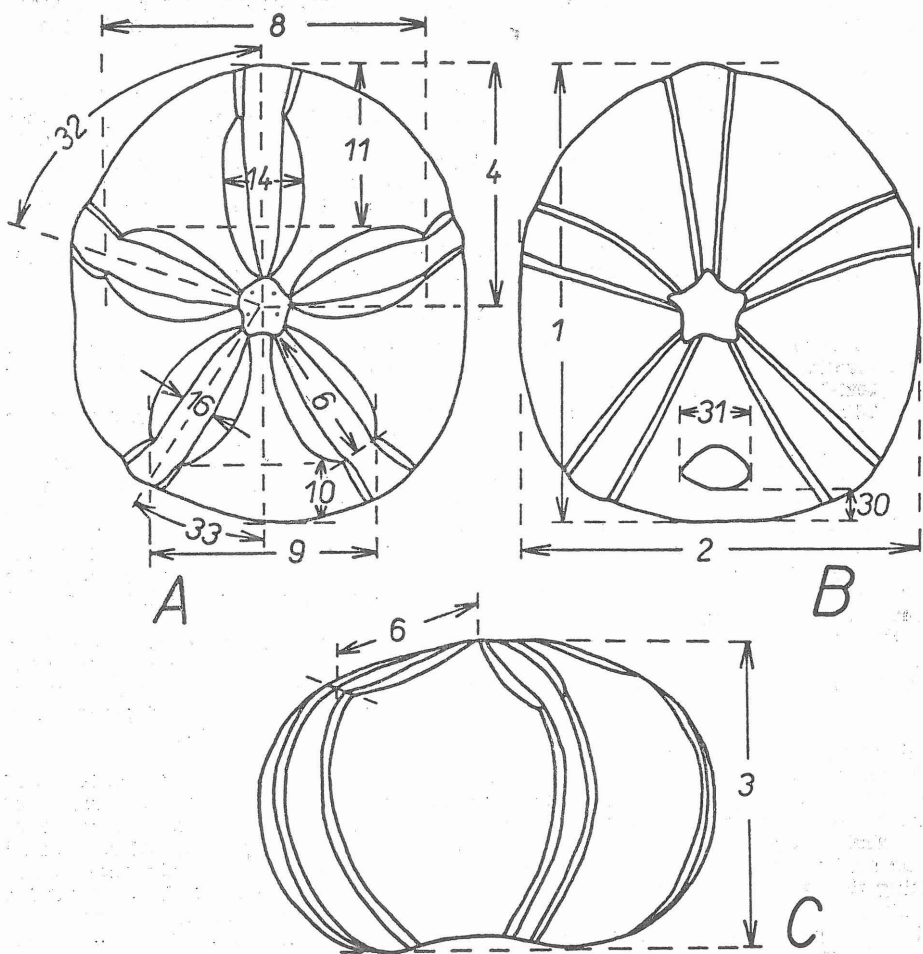

Fig. 1 — Some dimensions measured on *Haimea* test. Numbers indicating the values correspond to numbers used similarly in the text and figures.

a-dorsal view, b-ventral view, c-lateral view, anteriorly on the right. 1- length (=L) of test, 2- width of test, 3- maximum height of test 4- distance of apical system from the anterior margin of test, 6- length of petal, 8- distance of anterior paired petals ends, 9- distance of posterior paired petals ends, 10- distance of line joining ends of posterior petals from the posterior margin of test, 11- distance of line joining ends of anterior paired petals from the anterior margin of test, 14- width of petal, 16- width of interporiferous zone, 30- distance of periproct from the posterior margin of test, 31- angle made by anterior paired petal and plane of symmetry, 32- angle made by posterior paired petal and plane of symmetry.

Fossils were measured identically with Chesher [1968, 1970]. Measurements were made with callipers (accuracy 0.1 mm). Angles were measured projected on the horizontal plane, and volumes by immersing the test into the water and measuring the volume of displaced fluid in a calibrated vessel.

Location of periproct has not been measured regarding the distance of peristome from the posterior margin of the test, as used by Kier [1967a]. It was determined in

agreement with other values, i.e. with regard to the total length of the test. Kier's method has been abandoned, for the centre of the peristome rather complicated in shape can hardly be determined exactly. On the other hand, the margin of periproct is defined unambiguously.

The exact number of pores beyond petals was determinable only in some specimens. Errors originated mainly owing to very bad visibility of pores near the peristome. As the pores are less numerous in this region, the error is not greater than 5 to 10 pores. Kier's experience, that pores beyond petals are usually visible even on badly weathered specimens has not been confirmed in the greater part of Cuban material.

Abbreviations used in the descriptive part of the text: N — number of measurements (i.e. specimens). \bar{x} — arithmetic mean.

Intervals of counted values are supplemented with the lengths of corresponding specimens in parantheses, e.g. height 60.0 (27.3 mm)—89.4 (16.00 mm) percent L.

VARIATION

A large number of values obtained [see the preceding part] was evaluated using simple bivariate and trivariate scatter diagrams, a part of them being included in the paper [text-figs. 2—4, 10—12, 14, 15].

The following values seem to be related directly to the test length: Width of the test [text-fig. 3A], distance of periproct from the posterior margin of the test [text-fig. 2A], width of petals [see width of petal III in text-fig. 2C], width of interporiferous zones, distance of apical system from anterior margin of the test, [text-fig. 3B], distance of line joining the ends of posterior paired petals from the posterior margin of test [text-fig. 2B]. Direct relationship exists between the width of petals and their interporiferous zones. In the majority of cases the scatter of points in the scatter diagrams is relatively small. A wider scatter of points is shown in the scatter diagram of the height/length ratio of the test [text-fig. 10]. The same was found out by Kier (op. cit.) on the Jamaican specimens (*H. alta*).

In the relationship of the sum of petal lengths [in paired petals only one from a pair plus petal III] and the test length a clear allometry becomes evident [text-fig. 11A]. Younger individuals have their petals generally shorter than the older. Allometry of the reverse nature appears in the relationship between the number of porepairs in petal III and the size of the test represented by its length [text-fig. 12]. For more details see ontogeny in the description of *H. alta*.

The mere number of primary plates seems to be unsuitable for the differentiation of *H. alta* and *H. subcylindrica*. Their more extreme variants having similar numbers of primaries have to be recognized by other characters. Variation of the sequence of interambulacral plates [counted from peristome] contacting the petal distal ends could not be studied for the small number of observations. However, interambulacral plates forming the margin of periproct could be counted in 34 specimens of *H. alta* [text-fig. 13]. Most frequently plates 5, 6 [counted from peristome] in columns 5a, 5b, respectively, contact the periproct margin. All species from the Loma Caoba locality show similar counts. From this it follows that in *H. subcylindrica* with more anterior periproct the interambulacral plates are on the average shorter in peristomial region.

The relationship of the test width in percent L and the distance of periproct from the posterior margin in percent L shows well the general difference between *H. alta* and *H. subcylindrica* [text-fig. 14B]. Similar scatter of points is also shown by the relation of the height of test to the location of periproct in percent L [text-fig. 14A]. Although some extreme specimens have the same relative periproct location, other characters distinguish them easily.

This is primarily the question of the composition of ambulacra beyond the petals, but regarding a great variation, more sections from various ambulacra parts have to be studied. It holds in general that the simplest structure is present immediately beyond the petals and near the peristome. On the other hand, at ambital region the small plates are always most crowded [see Kier, op. cit.]. The necessity of a good enough preservation of fossils for such observations is evident.

Some specimens proved to have the demiplates adradially sharply ended, in others these were rather rounded. All these minute characters are evidently greatly influenced by weathering, which excludes any reliable conclusions. It would be interesting, however, to study similar details in great collections of well preserved specimens, even if the poor visibility of sutures would make the work very difficult.

Triads of small plates on adradial suture were very scarce in the studied collection of *H. alta*, similarly as observed by Kier (op. cit.) on Jamaican specimens [see syste-

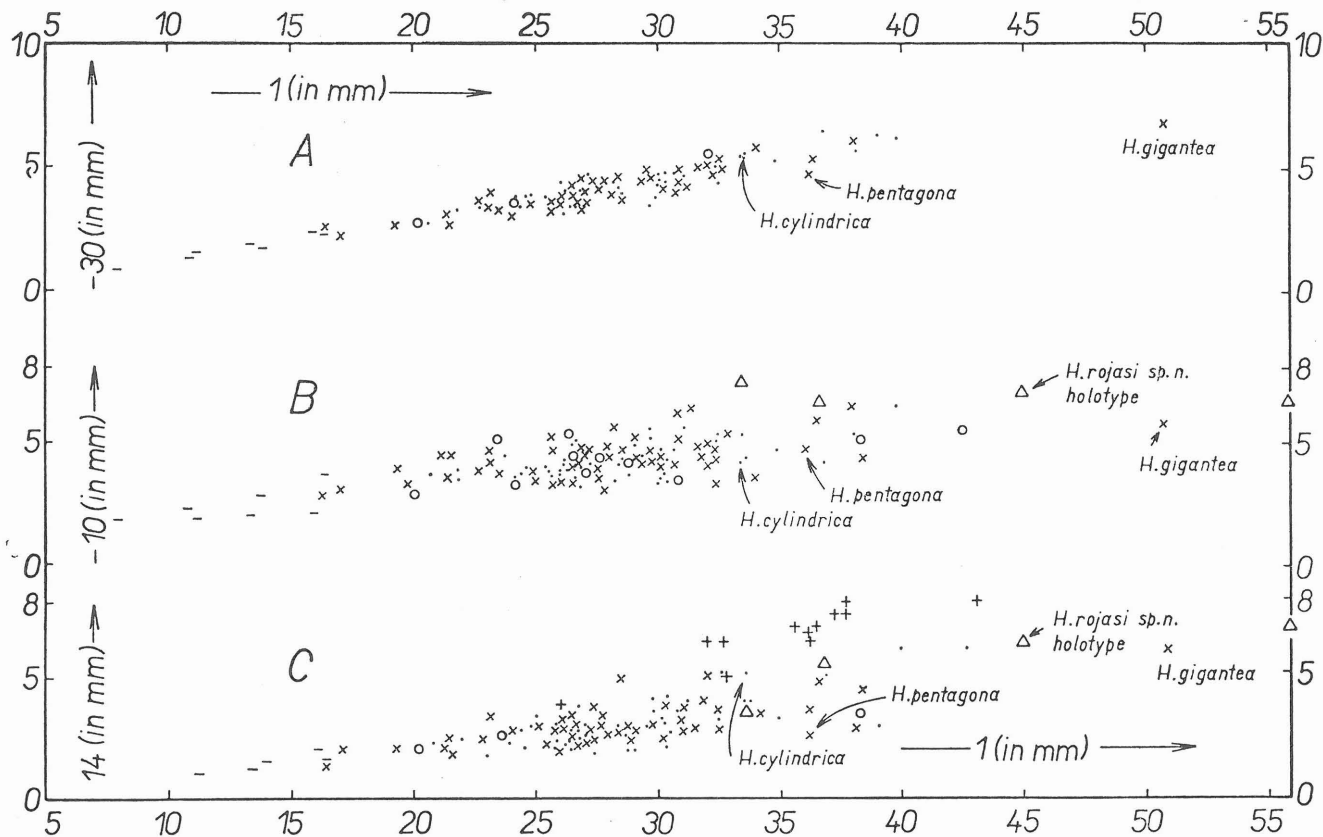

Fig. 2 — A — Distance of periproct from the posterior margin of test [30] relative to length of test [1] in *H. alta*. B — Distance of line joining posterior petal ends from the posterior margin of test [10] relative to length of test [1] in *H. alta* and *H. rojasi sp. n.* C — Width of petal III [14] relative to length of test [1] in *H. alta*, *H. subcylindrica*, and *H. rojasi sp. n.* *H. alta* — x (males), points (females), circles (sexes not preserved), stroke (sexes not developed). *H. subcylindrica* — crosses. *H. rojasi sp. n.* — triangles.

matic part). Some specimens with extraordinary occurrence of triads (one plate included) were in other characters indistinguishable from the normal ones of the same locality.

A mutual contact of demiplates of one half-ambulacrum (column) has to be appreciated very carefully with regard to weathering (see Kier op. cit., p. 7). In my materials of *H. alta* all specimens with preserved tubercles showed a primary contact of the demiplates, similarly to *H. sp.* The other studied species (*H. subcylindrica*, *H. rojasi*) are characterized by a more complex structure of ambulacra. Their plate groups are, therefore, of greater vertical range and always in contact. In this context it should be emphasized that weathering had only a slight effect on the structure of ambulacra in *H. rojasi* sp. n. Although all specimens (and especially those from Sancti Spiritus) are highly corroded, demiplates and included plates are locally preserved and their groups yet in contact. This indicates that the thickness of those plates is greater than is obvious. As, however, weathering must have affected the structure as a whole, we may suppose a yet more complex original structure, with some superficial plates, which are not preserved (ambulacral pores are, unfortunately, indistinct).

Lengths of petals were compared in *H. alta* (text-fig. 15). Only a slight scatter of points gives evidence of a very stable character of the series studied. The points for *H. subcylindrica* and *H. sp.* are not separated from those of *H. alta*, but their samples are not representative enough. It would be necessary to test the systematic importance of the found relation in more numerous samples of other taxa.

The measured volume of test (in millilitres) shows clear dependence on the length even if the test height varies greatly (text-fig. 4). The relationship between the test volume and the sum of petal lengths is of similar type (text-fig. 11A). The test volume could be measured in a part of specimens only. To make obvious their distribution in the whole sample, they are marked in the text-fig. 11B (ratio of the test length to the sum of petals lengths). As can be seen, the representation of volume measurements is relatively regular within a sample.

As regards the size of genital pores, 465 specimens of *H. alta* were investigated (selection made from about 800 specimens). On the whole, 207 specimens with greater and 258 with smaller pores were found. No intermediates were ascertained and no correlation of pore size to other morphological characters was found either (see sexes marked in all scatter diagrams). The question of sexual dimorphism (the females — large pores, the males — small) was discussed by Kier (1967a,b, 1968, 1969). By measurement and evaluation of various characters of tests, some data were obtained which will be usable mainly in future comparative studies. At the present time comparisons could be realized to a rather limited extent (incl. *H. alta* from Jamaica).

Some values considered in the systematic part are not generally used by echinologists (e.g. distance of petal ends, angle orientation of them, distance of the line joining the ends of petals from margins of test a.o.). All these apparently superfluous data, however, serve to the most complete characterization of the taxa studied, even though all the work has been considerably time-consuming. The nature of the material itself was relatively very favourable to such a study. Tables 2 and 3 and plates include some concrete specimens which may provide at least a minimum basis for comparison of all the characters. Some dimensions could not be, nevertheless, obtained in a sufficient number and accuracy (i.e. peristome).

ABNORMAL SPECIMENS

At Loma Caoba locality, a large number of primary deformations of a brissid *Eupatagus* (*Eupatagus*) *caobaense* SÁNCHEZ ROIG occurs, concerning largely the petals (narrowing, swallowing, increase in number of plates, absence of porepairs, increase of their number on a plate a.o. — see Žitt 1985a).

Any deformations of other echinoids from the locality including *Haimea* are, however, very rare. An only specimen of *H. alta* was found to be a tetramerous variant (No. 8027, not figured). Ambulacrum III of the specimen is missing and the anterior paired petals directed more anteriorly than usual. Nearly identical development was described by Kier (1967a, p. 39, pl. 12, fig. 3) from Jamaica (species indetermined), differing from the above specimen by the presence of all genital pores (our specimen has one pore reduced).

The only specimen of *H. subcylindrica* was found to be a complete hexamerous variant (pl. 6, figs. 1—3, 7).

Similar but incomplete deformation occurs on one highly weathered specimen of *H. sp.* It agrees well with the development described by Kier (op. cit., p. 39, pl. 12, figs. 1, 2, text-fig. 22) on *H. sp.* from Jamaica as a partial hexamerous variant. Our specimen (No. 8148, pl. 8, fig. 8, text-figs. 5—8) has four genital pores and in ambulacrum III two oculars are present (similarly as in Kier's specimen). Ambulacrum III is, namely, doubled from the apical system. Both parts of ambulacrum III (or ambulacrum III and one extra ambulacrum) are in close contact within the range of normal petal III length. Ambulacral plates of columns in contact are enlarged, their porepairs being only slightly developed to partly reduced and distally they vanish completely. Between both petals III no interambulacral plates are inserted (in the Jamaican specimen they are present). Separation of the two petals III does not occur before their distal ends and continue to the ambitus, where petals contact each other a new.

In the space between the two separated ambulacra many plates, some of them evidently ambulacral and other interambulacral, are present (text-figs. 6—8). Dorsally, beyond the ambitus, the ambulacra close each other and demiplates are very scarce. Primary plates of neighbouring ambulacra alternate. Near to the peristome the two ambulacra separate again and a small "window" with interambulacral plates bordered by some demiplates appears. More adorally, as far as the peristome, the central pore zones disappear, being substituted by a column of primary plates. Thus the ambulacrum consists of three columns of primary plates and two marginal columns of demiplates. Close to the peristome, however, this development turns back to the normal condition of the only ambulacrum.

With regard to the general development, the Jamaican specimen having the ambulacra separated not only in subpetaloid, but also in petaloid region, represents a much higher abnormality. His frontal interambulacrum is regular and of usual two-columns composition (see Kier op. cit., pl. 12, fig. 2). Nevertheless, in both the Jamaican and Cuban specimens the only ambulacrum III is present at the margin of peristome

SYSTEMATIC PART

Oligopygoida KIER

Haimea MICHELIN

For synonymy see Kier (1967a), p. 91

Type species: *Haimea caillaudi* MICHELIN, Middle or Late Eocene, Jamaica (see Kier op. cit., p. 97)

Species: See Kier (op. cit., p. 94, 129—130).

Stratigraphic range: Middle to Late Eocene

Haimea alta (ARNOLD et H. L. CLARK, 1927)

Pl. 1, figs. 1—8; pl. 2, figs. 1—9; pl. 3, figs. 1—7; pl. 4, figs. 1—5; pl. 5, fig. 5; pl. 7, figs. 1—3.

1927 *Pauropygus altus* ARNOLD et H. L. CLARK. — B. W. Arnold et H. L. Clark, p. 33, pl. 4, figs. 15—17

1934 *Haimea alta* (ARNOLD et H. L. CLARK). — B. W. Arnold et H. L. Clark, p. 143

1934 *Haimea caillaudi* MICHELIN (in part). — B. W. Arnold et H. L. Clark, p. 143

1953 *Haimea gigantea*, nov. sp. SÁNCHEZ ROIG. — Sánchez Roig, 1953a, p. 143, pl. 3, figs. 6, 7

1953 *Haimea pentagona*, nov. sp. SÁNCHEZ ROIG. — Sánchez Roig, 1953a, p. 142—143, pl. 3, figs. 8, 9

1953 *Haimea gigantea* nov. sp. SÁNCHEZ ROIG. — Sánchez Roig, 1953a, p. 143, pl. 3, fig. 11

1967 *Haimea alta* (ARNOLD et H. L. CLARK) (in part). — Kier, 1967a, p. 102—107, pl. 4, fig. 3, pl. 25, fig. 5, pl. 26, figs. 1—5.

Holotype: Specimen figured in Arnold et H. L. Clark (1927), pl. 4, figs. 15—17 and again in Kier (op. cit.), pl. 26, fig. 1, No. 3271, deposited in the Museum of Comparative Zoology, Cambridge, Massachusetts.

Paratypes: 35 specimens, Nos. 3395 and 3396 (according to Kier op. cit.) deposited along with the holotype.

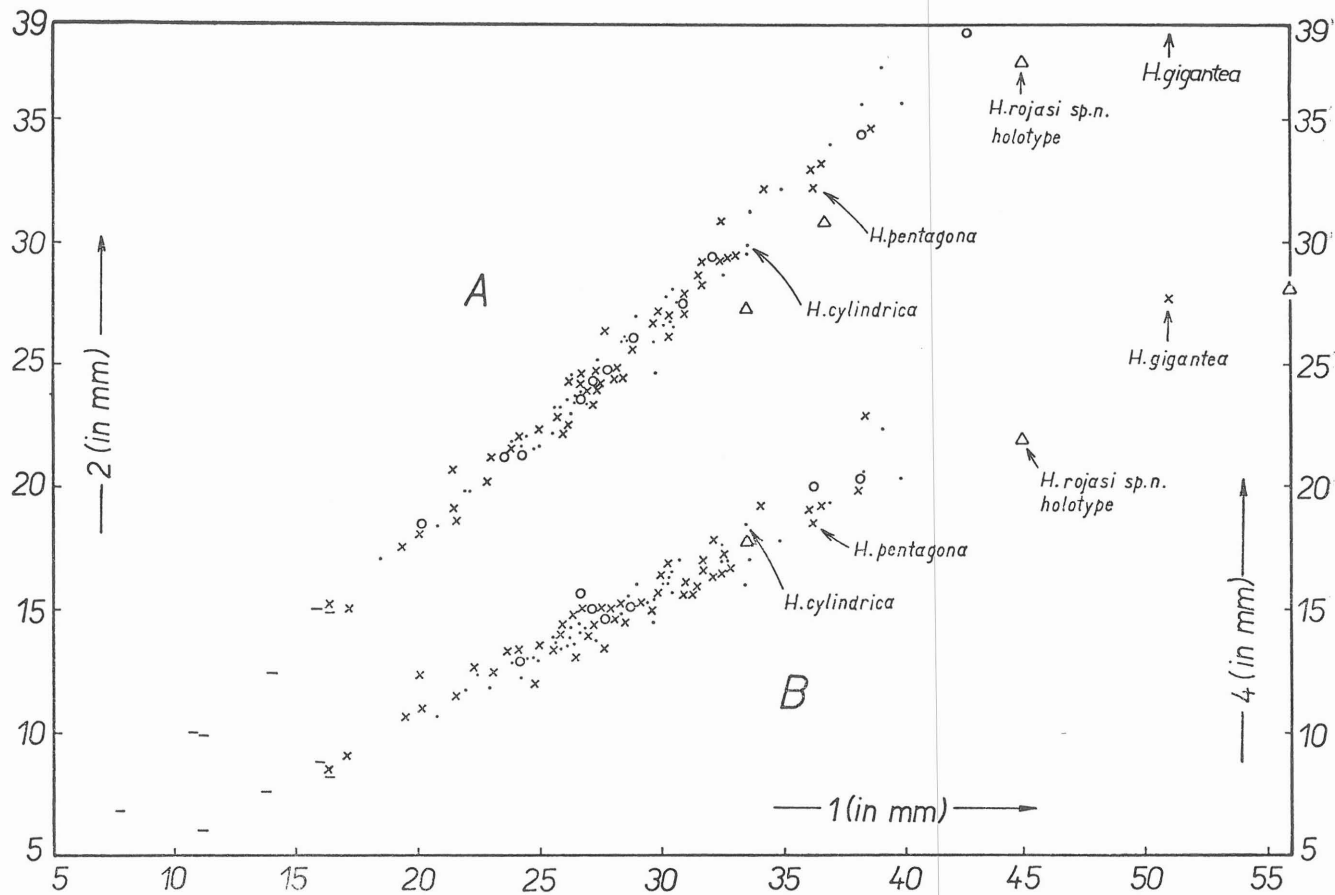

Fig. 3 — Width [2] relative to length [1] in *H. alta* and *H. rojasi* sp. n. B — distance of apical system from the anterior margin of test [4] relative to length [1] in *H. alta* and *H. rojasi* sp. n. Probable sexes designated as in text-fig. 2.

Type horizon and locality: Middle Eocene, Yellow Limestone, Spring Mount, St. James Parish, Lucky Hill, St. Mary, Jamaica.

Material: Beside the types of M. S. Roig (*H. pentagona* — No. 4244, *H. cylindrica* — No. 4220, and *H. gigantea* — No. 4270) other 119 well preserved specimens (Nos. 4370, 4384, 4398, 4406, 4409, 4412, 4422, 4424, 4431, 4439, 4449, 4464, 4465, 4467, 4477, 4479, 4484, 4503, 4536, 4544, 4582, 4585, 4593, 4601—04, 4609—12, 4614, 4617, 4621, 4624, 4625, 4627, 4630, 4656, 4790, 4793, 4804, 4863, 4865, 4868, 4917, 4919, 4940, 4952, 4978, 5903, 5908, 5913, 5922, 5924, 5931, 5947, 5949, 5961, 5968, 5974, 5979, 5983a, b, 5991, 5999, 6011, 6015, 6018, 6035, 6059, 6069, 6077, 6083, 6104, 6112, 6121, 6122, 6125, 6129, 6154, 6161, 6166, 6174, 6180, 6183, 6184, 6187, 6205, 6209, 6210, 6225, 6234, 6257, 6269, 6278, 6280, 6292, 6294, 6308, 6309, 6332, 6336, 6355, 6357, 6367, 6370, 6378, 6381, 6389, 8027, 8034, 8106, 8123, 8132, 8141, 8155, 8163, 8174) and 680 specimens and fragments of worse preservation. All specimens come from the Canteras de Caraballo locality, Loma Caoba Hill near San Diego de los Baños, Pinar del Río province, and represent the new collections made by the author during 1974—1975. All the material is deposited in the collections of the Geological and Paleontological Institute of the Academy of Sciences of Cuba in Havana.

DESCRIPTION

Shape and size: Length [=L] 7.9—40.0 mm (holotype of *H. gigantea* 51.0 mm), \bar{x} = 28.1 (N = 120). Test slightly elongate to nearly globose, width 79.0 (L = 26.2 mm)—96.3 (L = 21.4 mm) percent L, \bar{x} = 87.6 percent (N = 119), maximum width at level of apical system. Height of test 60.0 (27.3 mm)—89.4 (16.0 mm) percent L, \bar{x} = 71.7 percent (N = 115), maximum height at apex or slightly anterior. Test of rounded to pentagonal outline (holotype of *H. pentagona*), in some specimens posteriorly truncated. Adoral part a little swollen anteriorly to peristome.

Apical system: Monobasal, four genital pores, anterior part smaller and with pores closer together than posterior. Some specimens with all pores generally greater than others (see above, chapter on variation). Apical system subcentral, distance of its center from anterior margin of test 48.3 (29.8 mm)—60.4 (20.2 mm) percent L, \bar{x} = 54.3 percent (N = 110). The smallest specimen with genital pores 16.3 mm long.

Ambulacra: Petals well developed, flush or with slightly convex interporiferous zones open distally.

Petal III longest, ist length 22.8 (7.9 mm)—41.3 (39.2 mm) percent L, \bar{x} = 34.2 percent (N = 110). Relative length from the sum of lengths I (V), II (IV), and III 32.9—37.5 percent (N = 113) (see text-fig. 15). Width 10.1 (7.9 mm)—17.3 (37.0 mm) percent L, \bar{x} = 14.1 percent (N = 101), width of interporiferous zone 30.8 (26.3 mm)—65.0 (27.0 mm) percent of petal width, \bar{x} = 50.6 percent (N = 98), interporiferous zone therefore about twice as wide as poriferous zone. Pores strongly conjugate, mostly obliquely oriented. Outer pore of pair greater, elongated, in proximal parts of petal situated similarly or more proximally, in distal parts of petal always more distally to inner pore. Numbers of porepairs of some specimens see tab. 1.

Anterior paired petals (II, IV) shortest, their length 16.5 (7.9 mm)—36.6 (32.5 mm) percent L, \bar{x} = 30.3 percent (N = 110). Relative length

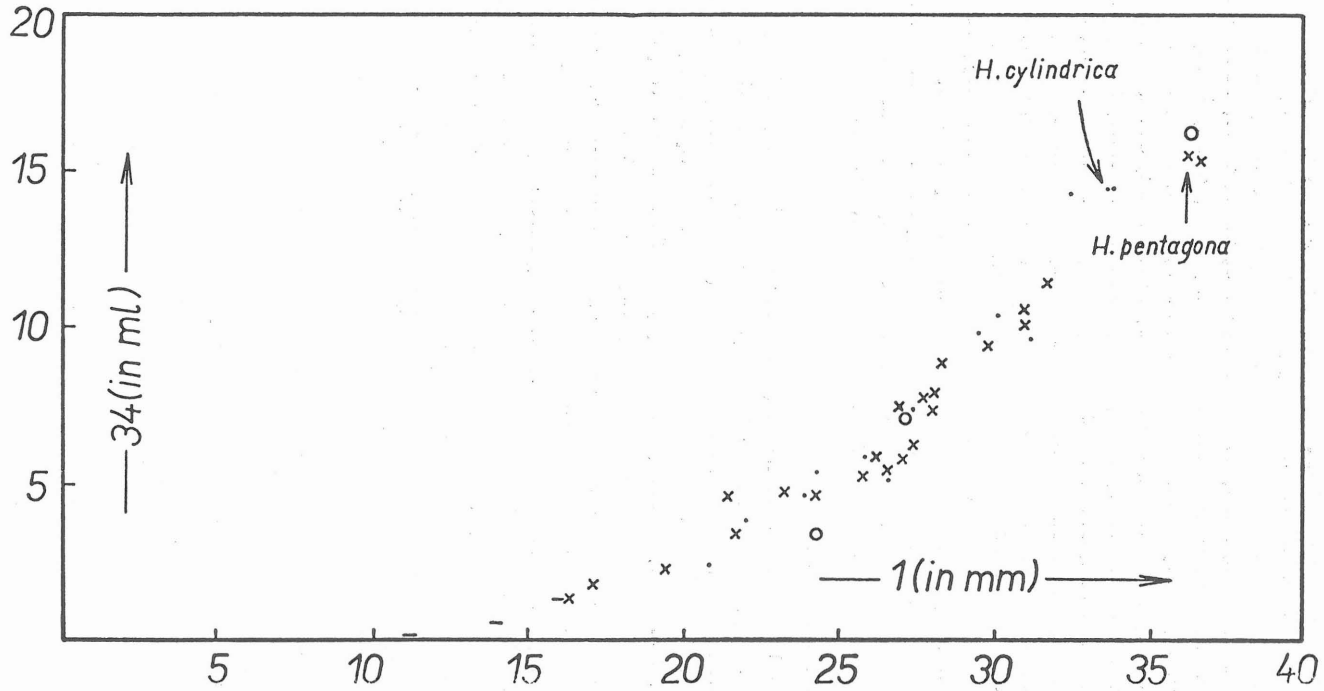

Fig. 4 — Volume of test (34) relative to length of test (1) in *H. alta*. Probable sexes as in text-figs. 2 and 3.

from the sum of lengths I (V), II (IV), and III 28.9—34.8 percent L (N = 113) (see text-fig. 15). Width 10.1 (17.9 mm)—17.4 (36.3 mm) percent L, \bar{x} = 13.9 percent (N = 113), width of interporiferous zones 28.2 (26.3 mm)—66.7 (27.0 mm) percent of petal width, \bar{x} = 51.3 percent (N = 108), interporiferous zone therefore as in petal III (see above). Porepairs as in petal III as well. Numbers of porepairs see tab. 1. Angle made by petal and plane of symmetry (measured anteriorly) 65.0 (22.0 mm)—75.0° (21.4 mm), \bar{x} = 70.2° (N = 107), distance of petal ends 40.5 (25.8 mm)—74.6 (37.0 mm) percent L, \bar{x} = 61.9 percent (N = 102), distance of line joining distal ends of petals from anterior margin of test 31.3 (26.2 mm)—43.6 (20.2 mm) percent L, \bar{x} = 35.2 percent (N = 110).

Length of posterior paired petals (I, V) 20.3 (7.9 mm)—43.1 (32.5 mm) percent L, \bar{x} = 32.4 percent (N = 110). Relative length from the sum of length I (V), II (IV), and III 30.4—36.1 percent (N = 113) (see text-fig. 15). Width 10.1 (7.9 mm)—17.3 (27.1 mm) percent L, \bar{x} = 14.5 percent (N = 107), width of interporiferous zones 26.8 (26.2 mm)—65.3 (35.0 mm) percent of petal width, \bar{x} = 47.1 percent (N = 108). Porepairs as in other petals, their numbers see tab. 1. Angle made by petal and plane of symmetry (measured posteriorly) 31.0 (29.5 mm)—40.0° (26.8 mm), \bar{x} = 34.1° (N = 107), distance of petal ends 38.8 (13.9 mm)—55.0 (32.2 mm) percent L, \bar{x} = 47.6 percent (N = 102), distance of line joining distal ends of petals from posterior margin of test 9.5 (32.6 mm)—22.8 (7.9 mm) percent L, \bar{x} = 15.0 percent (N = 108).

The width of ambulacra beyond petals mostly smaller or approaching maximum width of petals. Ambulacra I (V) and III are straight between petals and peristome, ambulacrum II (IV) curves slightly posteriorly in adoral part. Ambulacra beyond petals composed of primary plates and demiplates on adradial suture. The latter may be separated from each other secondarily by primary plates, but in well preserved specimens they are always in contact, in the main at ambitus, and primary plates then become occluded. Near to the peristome and the ends of petals they are separated by primary plates. One demiplate belongs to every suture between primaries. Extraordinarily, the occurrence of groups of three plates was ascertained, their central member being included. These plates are most crowded at ambitus of ambulacra, being most numerous in posterior ones. Pore zones are very narrow, flush or slightly depressed, interporiferous zones very wide (text-fig. 16 F) and mostly slightly inflated. Pores arranged in double rows, often difficult to count. Ambulacrum III has about 124—160 pores (N = 34) in one pore zone. In II (IV) there is 126—162 pores (N = 49), in I (V) about 128—180 pores (N = 41). Number of primary plates in III 55—81 (N = 33), in II (IV) 51—83 (N = 39), and in I (V) 53—83 (N = 35) plates in one column (further details see remarks). Buccal pores distinct.

Interambulacra: Complete number of plates depends on the size of specimen (some values see text-fig. 1), but the sequence of plates bordering distal ends of petals (counted from peristome) is not affected by growth. The end of petal I (in 5b, 1a) and petal V (in 4b, 5a) is surrounded by plates 11—13 (N = 31); petal II (in 1b, 2a) and IV (in 3b, 4a) by plates 10—14 (N = 34); petal III (in 2b, 3a) by plates 11—14 (N = 31). This feature is thus approximately identical in all interambu-

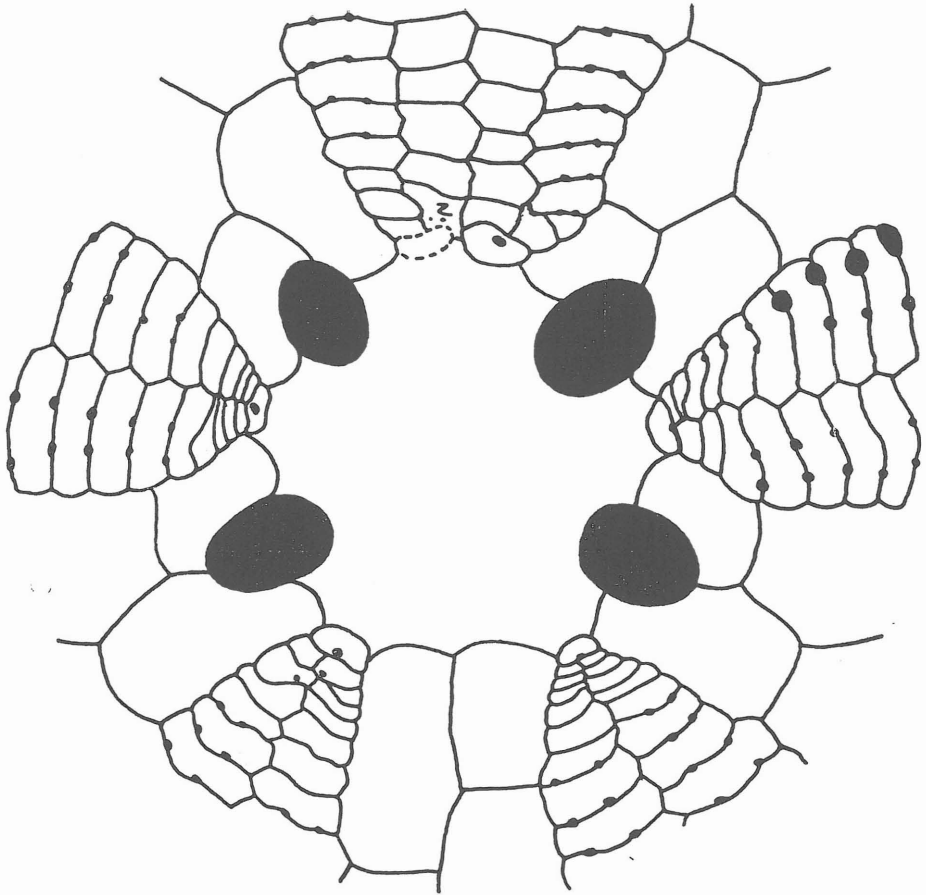

Fig. 5 — The apical system of partial hexamerous specimen of *H. sp.*, No. 8148. x 15.0.

laca, although in concrete specimens in 2b, 3a (near the end of petal III) there is usually one more plate than in the other interambulacra.

Peristome: Pentagonal, slightly posterior, bourrelets moderately developed. Sphaeridia in double row in each ambulacrum near peristome.

Periproct: Inframarginal, transversely elongated, from posterior margin of test located 6.9 (29.0 mm)—16.5 (28.5 mm) percent L, \bar{x} = 10.3 percent (N = 113). Transverse diameter 7.1 (32.6 mm)—18.0 (11.1 mm) percent L, \bar{x} = 11.3 percent (N = 92). Periproct in well preserved specimens sharpened anteriorly. Distribution of plates bordering periproct (in 5a, 5b) see text-fig. 13. Their maximum number totals six.

Tuberculation: Primary tubercles small, crenulated, perforated, scrobiculated [scrobicules with vertical sides]. Mamelon slightly protruding above the test surface. Tubercles arranged regularly on the whole surface. Area between them, similarly to madreporite, occupied by small secondary tubercles.

Table 1

Principal values of some selected specimens of *H. alta* (designation of values see p. 2). Value No. 1 in mm, Nos. 2—14, 30, 31 in percent L, Nos. 15—17 in percent of petal width, Nos. 32, 33 in angle degrees. No. 34 in ml.

Number of specimen	6289	6154	6059	5913	6357	6234	Holotypes		
							4244 H. pent.	4220 H. cyl.	4270 H. glg.
Designation of value									
1	32.6	32.2	28.4	27.3	16.3	11.1	36.3	33.6	51.0
2	88.3	86.9	87.3	88.3	93.3	89.2	89.0	89.0	87.1
3	77.3	62.7	72.5	75.5	79.8	73.0	65.0	76.2	72.7
4	52.1	50.9	53.2	52.4	51.5	54.1	52.3	55.1	54.3
5	30.7	29.6	27.8	28.9	27.6	21.6	32.0	32.1	33.9
6	32.2	36.0	32.0	31.5	29.4	23.4	35.3	33.6	39.0
7	33.7	35.1	32.0	33.3	30.7	26.1	34.2	38.1	42.0
8	62.9	64.6	58.1	61.2	59.5	52.3	66.1	66.1	67.3
9	44.8	55.0	44.0	48.5	44.2	39.6	48.2	49.7	48.4
10	16.0	14.9	15.8	16.8	16.0	16.2	12.4	12.2	11.2
11	35.6	32.9	37.3	37.0	37.4	38.7	37.2	36.6	38.4
12	13.5	16.8	16.5	13.9	14.7	12.6	13.2	14.6	12.7
13	13.8	c. 15.8	13.0	13.6	14.7	11.7	12.7	15.2	11.6
14	13.2	15.5	13.4	14.3	14.7	13.5	12.9	15.5	13.1
15	50.0	44.4	38.3	55.3	50.0	42.9	47.9	51.0	40.0
16	46.7	—	43.2	56.8	50.0	46.2	45.7	54.9	33.9
17	44.2	50.0	44.7	53.8	50.0	40.0	48.9	53.8	46.3
18	26	27	26	25	19	14	29	26	42
19	28	30	31	27	20	15	33	29	45
20	29	c. 30	29	27	20	16	32	31	47
21	—	c. 136	c. 136	c. 160	—	—	—	—	—
22	—	c. 152	c. 154	c. 174	—	—	—	—	—
23	—	c. 136	c. 146	—	—	—	—	—	—
24	72	c. 69	c. 70	83	c. 67	64	75	—	c. 62
25	78	c. 73	c. 76	82	c. 73	67	80	—	c. 75
26	74	—	c. 77	76	c. 65	60	75	—	—
27	18	18	17	17	16	14	19	—	—
28	19	19	19	20	17	17	21	—	—
29	> 16	19	18	18	17	14	19	—	—
30	16.0	15.8	9.5	7.7	9.8	9.0	7.4	15.5	11.8
31	8.9	10.2	10.9	10.6	14.1	18.0	8.5	11.0	6.1
32	67.0	67.0	69.0	70.0	70.0	68.0	74.0	71.0	69.0
33	35.0	36.0	33.0	36.0	33.0	35.0	33.0	33.0	33.0
34	—	—	8.8	—	1.3	0.2	15.4	14.4	44.4

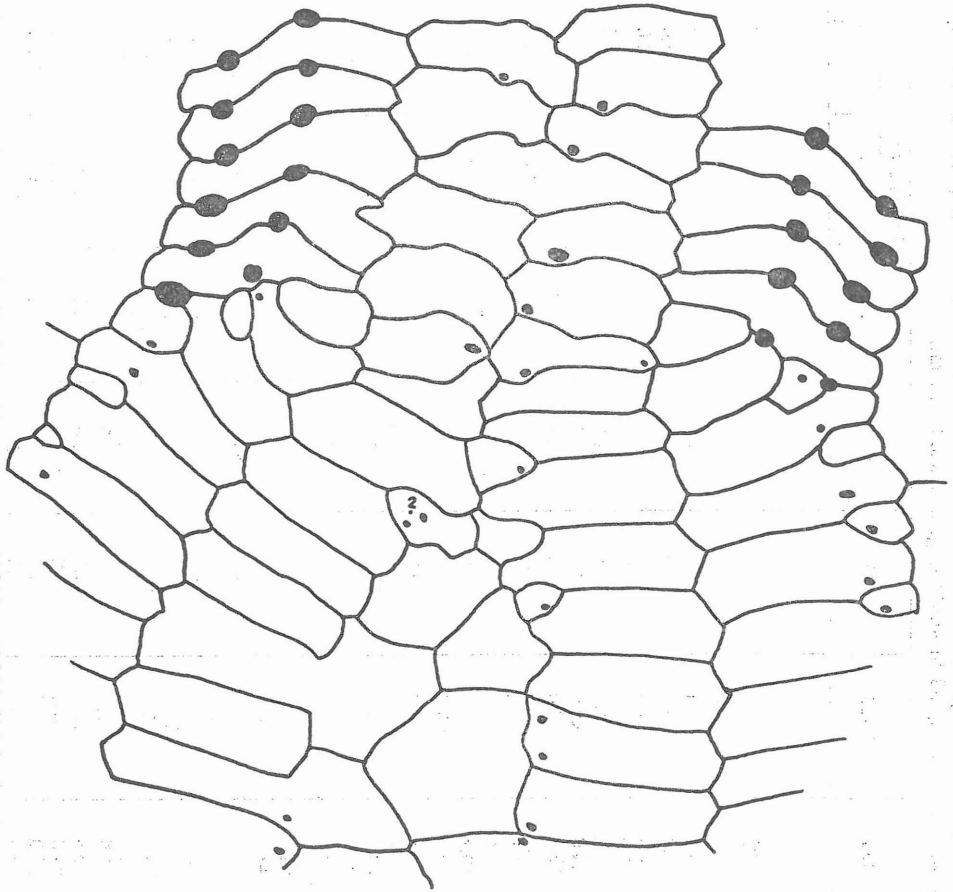

Fig. 6 — Plate arrangement in ambulacrum III beyond the petal of partial hexamerous specimen of *H. sp.*, No. 8148. x 14.0.

Volume of test: Forty three specimens of several growth stages measured from 0.2 ml ($L = 11.1$ mm) to 44.4 ml ($L = 51.0$ mm, holotype of *H. gigantea*). For relation to other dimensions see text-figs. 4, 11.

Ontogeny: The smallest specimen found is 7.9 mm, the largest 40.0 mm long (in addition to *H. gigantea* with $L = 51.0$ mm). Within this size range only a few phenomena were ascertained to distinguish the young specimens from the adult ones. The smallest specimen has 11 porepairs in a single column of petal III, in II (IV) 8 porepairs, and in I (V) 8 porepairs. The difference of one to three porepairs between petals III and I (V) holds for the whole growth of most specimens, similarly as the difference between petal III and petal II (IV). The smallest specimen with genital pores developed is 16.3 mm long (see tab. 1, No. 6357). The specimen from Jamaica was 10.0 mm long (see Kier 1967a, p. 103).

During growth the total length of petals increases more rapidly than the test length (text-fig. 11B). The number of porepairs in petal III, on

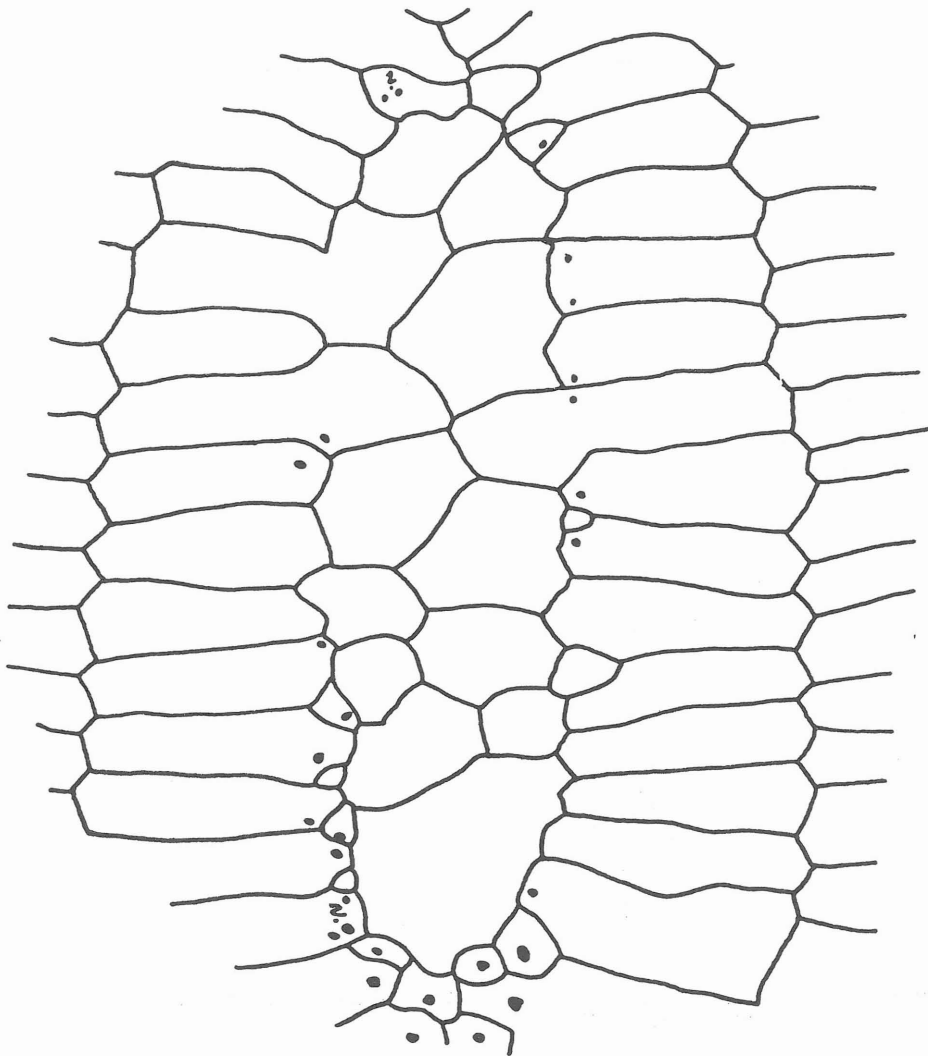

Fig. 7 — Plate arrangement in ambulacrum III at the ambitus of partial hexamerous specimen of *H. sp.*, No. 8148. x 14.0.

the other hand, slightly decreases during growth (text-fig. 12). This signifies that during growth the petal length is more and more achieved by the growth of the existing plates and the rate of introducing new plates decreases. The increase of porepairs number in paired petals depends, however, directly on the test length.

Remarks and relations: *H. alta* has been found in Cuba for the first time by Sánchez Roig (1949) who records (op. cit., p. 121, 122) forty three specimens from the Loma Caoba locality (the largest one 31.5 mm long). He has written that "Sus caracteres convienen con los

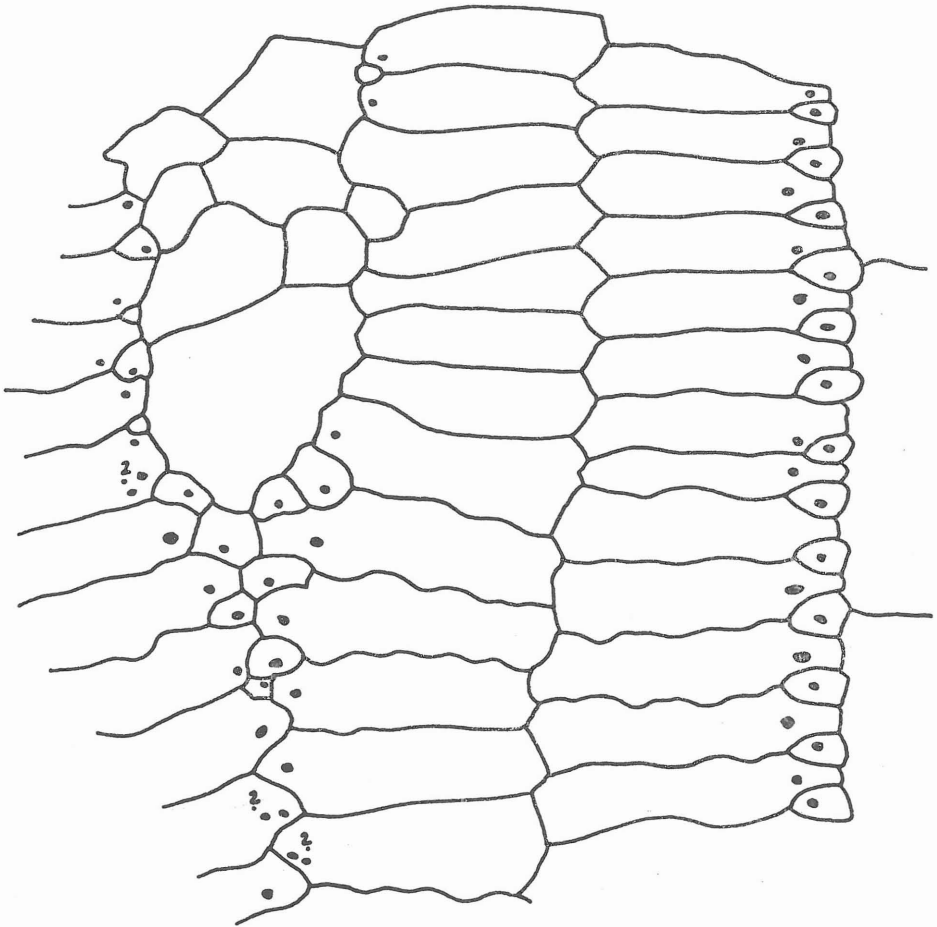

Fig. 8 — Plate arrangement in ambulacrum III slightly beyond the ambitus of partial hexamerous specimen of *H. sp.*, No. 8148. x 14.0.

señalados por Clarck . . .” (the age is erroneously given as Late Eocene). He studied the genus *Haimea* four years later again (S. Roig 1953a) and described four new species. *H. alta* has not been mentioned in this paper. From the text it does not, however, follow the determination of his previous material to be invalid or erroneous, which implies that altogether five species have been recognized in the material from Loma Caoba. In addition to *H. alta* these are *H. cylindrica* S. ROIG, *H. pentagona* S. ROIG, *H. gigantea* S. ROIG, and *H. subcylindrica* S. ROIG, each of them being described on the basis of one specimen only. Sánchez Roig’s descriptions of new species are, unfortunately, too brief and inadequate and his illustrations very poor. Kier (op. cit.) not having at his disposal the type material and studying only topotypes in the U. S. National Museum, has

found no significant differences between S. Roig's species and synonymized them all with *H. alta*. After the types from the Geological Institute of the Academy of Sciences of Cuba in Havana had been examined, Kier's conclusions could be confirmed as concerns *H. cylindrica*, *H. pentagona*, and *H. gigantea*. *H. subcylindrica*, however, was found to represent a different species.

Differences between S. Roig's holotypes of the former three species and *H. alta* are slight and not significant taxonomically. Thus, e.g. the periproct of *H. cylindrica* S. ROIG is relatively anterior (see pl. 1, figs. 1, 2) and the peristome is very small, both features being typical of *H. subcylindrica*. The test is, however, high and no complex groupings of demiplates and included plates occur in *H. cylindrica*. Therefore, it seems

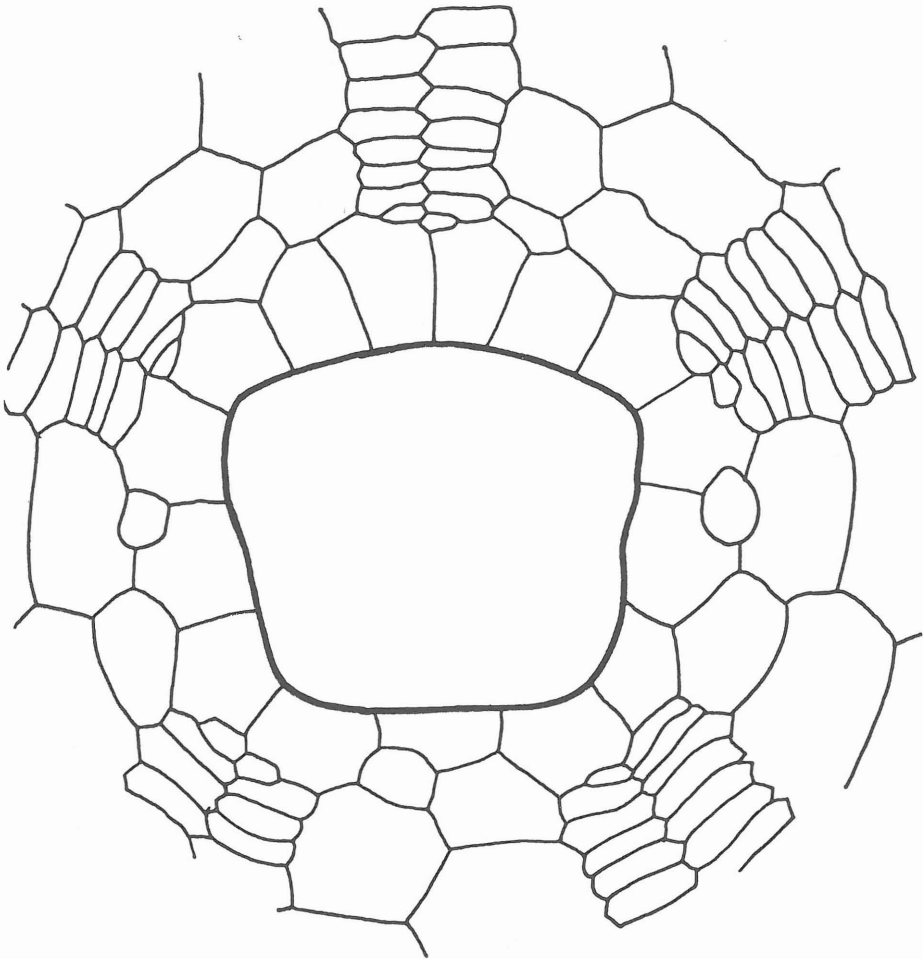

Fig. 9 — The peristomial region of badly weathered *H. alta* specimen. No demiplates preserved. No. 6209. x 13.0.

more reasonable to consider it as a variant of *H. alta* only. Of similar nature is the characterization of *H. pentagona*, the test of which is rather low, extremely pentagonal in outline, largely truncated posteriorly, and with the periproct located relatively posteriorly. The size of the specimen is extraordinary, indeed, but many smaller specimens approach it closely in morphology. Some specimens of intermediate character were, moreover, found. It is not therefore possible to confirm an independent species in this case, although the above features are very suggestive. As for the structure of ambulacra beyond petals see text-fig. 16E, *F. H. gigantea*, striking by its large size does not probably represent anything else but an extraordinarily grown specimen of *H. alta*. No other complete specimen of this size was found up to date, but some ill preserved fragments indicate similar test dimensions.

H. alta was described from the Middle Eocene of Jamaica by Arnold and H. L. Clark (1927) and type material (36 specimens) was revised by Kier (1967a). Length range of the series is from 16.0 to 36.0 mm, width equals 85.0—97.0 percent L. The lower limit for the width of Cuban specimens is 79.0 percent L (see above), many of them being narrower. The height of the Jamaican specimens ranges from 68.0 to 84.0 percent L and is lower than in those from Cuba. The average height of Jamaican specimens is 76.0 percent L from which it follows that they are higher (for comparison see fig. 10).

Number of primaries beyond petal III equals, according to Kier (op. cit.), 140 plates in Jamaican specimens, while in Cuban specimens it equals 110 to 162 plates. Total number of all plates beyond every petal in Jamaican specimens is, according to Kier (op. cit.), from 250 to 270 plates. In Cuban specimens it ranges from 250 to 320 [in III, II (IV)] and even up to 360 plates [in I (V)]. Scarce occurrence of triads of small plates on adradial suture was mentioned above. A specimen with an extraordinary high number of these groupings is figured on pl. 2 figs. 7—9.

Location of periproct is given by Kier (op. cit.) as 50.0—65.0 percent of the distance of peristome center from the posterior margin of the test. Converting these data to the here used values, new values of c. 9.5—17.0 percent L are obtained. As Cuban specimens have their periproct only 6.9—16.5 percent L distant from the posterior margin of the test, the difference is apparent. However, the measurement of the photograph of one paratype (No. MCZ 3395, see Kier op. cit., pl. 26, fig. 3) gave the value of about 11.6 percent L. This specimen, moreover, shows the peristome not to be central as given by Kier, but shifted posteriorly, similarly to the specimen from Loma Caoba (No. USNM 649848, topotype figured in Kier op. cit., pl. 26, fig. 6). All Cuban specimens I have studied display identical location of their peristomes. In other words, the values from Kier's data are partly increased as a result of assuming the central location of the peristome. Direct measurement of paratype (see above) shows that probably no important differences exist between the Jamaican and Cuban specimens. (Considered periproct size 8 % L.)

JAMAICAN AND CUBAN SPECIMENS

Some other species morphologically similar to *H. alta* have been described from Middle Eocene of Jamaica (see Arnold et H. L. Clark 1927). *Haimea elevata* (ARNOLD

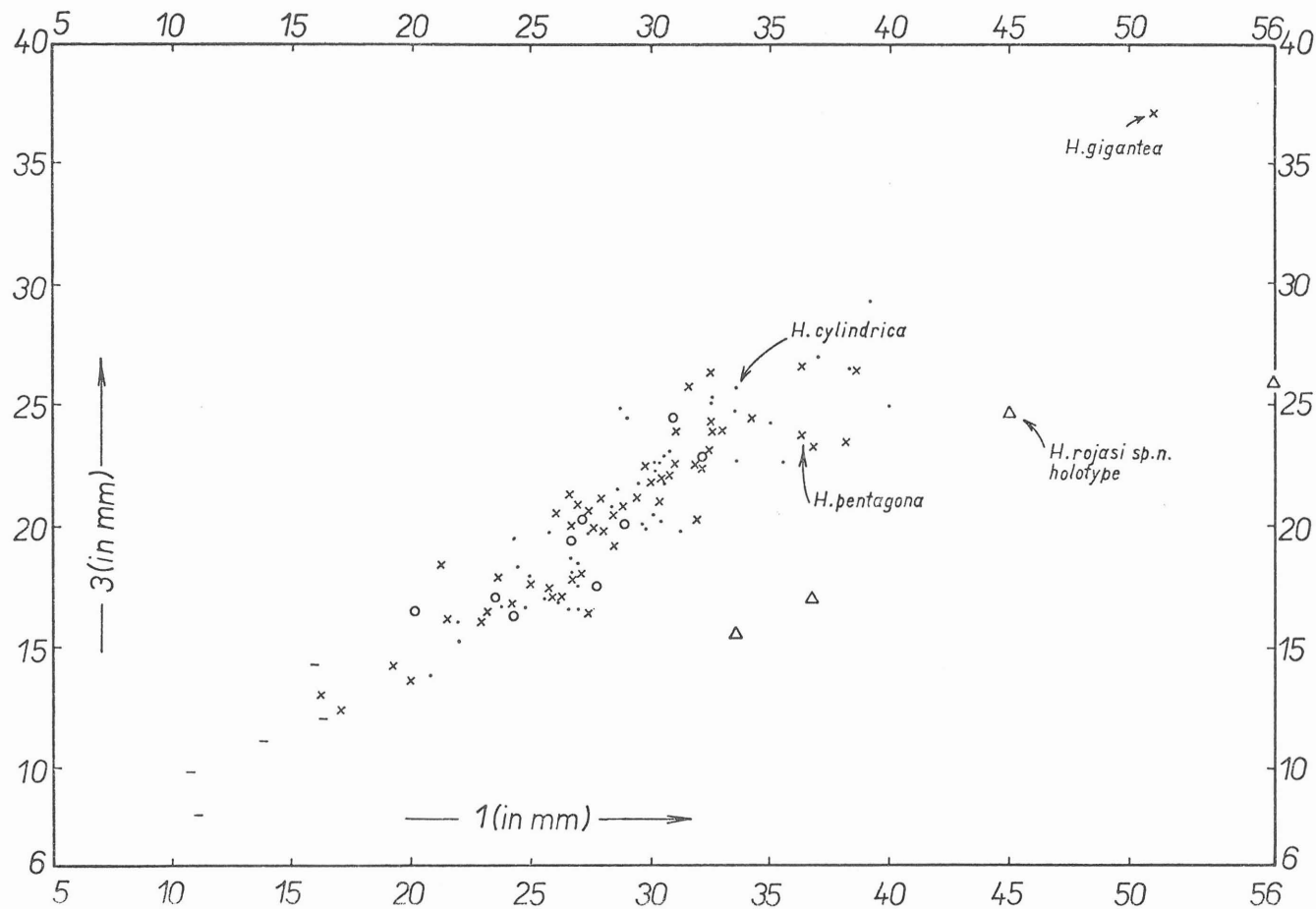

Fig. 10 — Height (3) relative to test length (1) in *H. alta* and *H. rojasi* sp. n. Probable sexes and species symbols as in text-fig. 2.

et H. L. CLARK] from the Yallah River in St. Thomas, may represent geographic subspecies of *H. alta*, as its occurrence is geographically separated, "but not enough is known of their stratigraphic occurrence to be certain that they are contemporaneous" [Kier op. cit., p. 102]. According to Kier [op. cit., p. 101, 102], Jamaican specimens of *H. alta* are wider than *H. elevata*. Among Cuban *H. alta* specimens however, occur some narrower specimens (width as small as 79.0 percent L) derived from the same locality as the wider ones and joined with them by various intermediates. For that reason, they cannot be considered as an independent species, but the identity of those specimens with *H. elevata* from Jamaica is not evidenced, the latter having fewer plates and pores beyond the petal III [see Kier op. cit.].

Haimea pyramidoides (ARNOLD et H. L. CLARK, 1927) is another problematic species, as the only one specimen is known from Jamaica (Hill west of Yallah River, St. Thomas). The test is highly inflated and as noted by Kier [op. cit., p. 108], it may belong to an aberrant specimen of another species. Its very flat ventral side and unusually anterior peristome are, however, very suggestive. Other characters agree with *H. alta*, an extremely deformed individual of which it may represent.

Haimea cylindrica (ARNOLD et H. L. CLARK, 1927) was collected originally between Seven Springs and Springfield, St. James, Jamaica, where both the Yellow Limestone and White Limestone crop out. The derivation of echinoids is not certain but Kier [op. cit.] thought the Yellow Limestone to be more probable horizon. Some minor differences from *H. alta* have been determined (demiplates not in contact either at the ambitus, fewer plates in ambulacrum beyond petals — in III about 200 plates present).

Haimea convexa (ARNOLD et H. L. CLARK, 1927) is known from the Yellow Limestone of a locality near Lucky Hill, St. Mary Parish, Jamaica. Only one specimen was originally found. In my opinion, the very long peristome is a partial deformation, but this and other characters (strongly inflated petals, deeply depressed poriferous zones, interambulacral plates with nodes adapically) are highly taxonomically appreciated by Kier [op. cit.]. At Loma Caoba no similar specimens were collected.

Haimea subcylindrica SÁNCHEZ ROIG, 1953

Pl. 5, figs. 1—4, 6—8; pl. 6, figs. 1—7; pl. 7, figs. 7, 8

1953 *Haimea subcylindrica*, nov. sp. SÁNCHEZ ROIG. — Sánchez Roig, 1953a, p. 141—142, pl. 3 figs. 4, 5

1967 *Haimea subcylindrica* SÁNCHEZ ROIG. — Kier, 1967a, p. 105

H o l o t y p e : Specimen figured in Sánchez Roig (1953a, see above) and again in this paper, pl. 5, figs. 6—8, No. 4195, deposited in the collections of the Geological and Paleontological Institute of the Academy of Sciences of Cuba in Havana.

T y p e h o r i z o n a n d l o c a l i t y : Middle Eocene, Canteras de Caraballo, Loma Caoba, San Diego de los Baños, Pinar del Río province.

M a t e r i a l : In addition to the holotype 12 well preserved specimens (Nos. 4458, 4593, 4595, 4596, 5951, 6060, 6101, 6143, 6193, 6194, 6196, 6296) all from new collections of the author made in the years of 1974—1975. All material deposited along with the holotype.

DESCRIPTION

S h a p e a n d s i z e : Length (= L) 26.0—43.2 mm, \bar{x} = 32.4 (N = 13). Tests low and wide, width 87.8 (32.7 mm)—93.8 (35.6 mm) percent L, \bar{x} = 90.8 percent (N = 13), maximum width at the level of apex or more posteriorly. Height of test 50.0 (36.2 mm)—66.6 (35.6 mm) percent L, \bar{x} = 60.1 percent (N = 12), maximum height at apical system or slightly posteriorly. Test rounded, ventral side flat, peristome little deepened. Test anterior to peristome not swollen.

A p i c a l s y s t e m : Monobasal, four genital pores, anterior pair smaller with pores closer together than posterior. Some specimens with

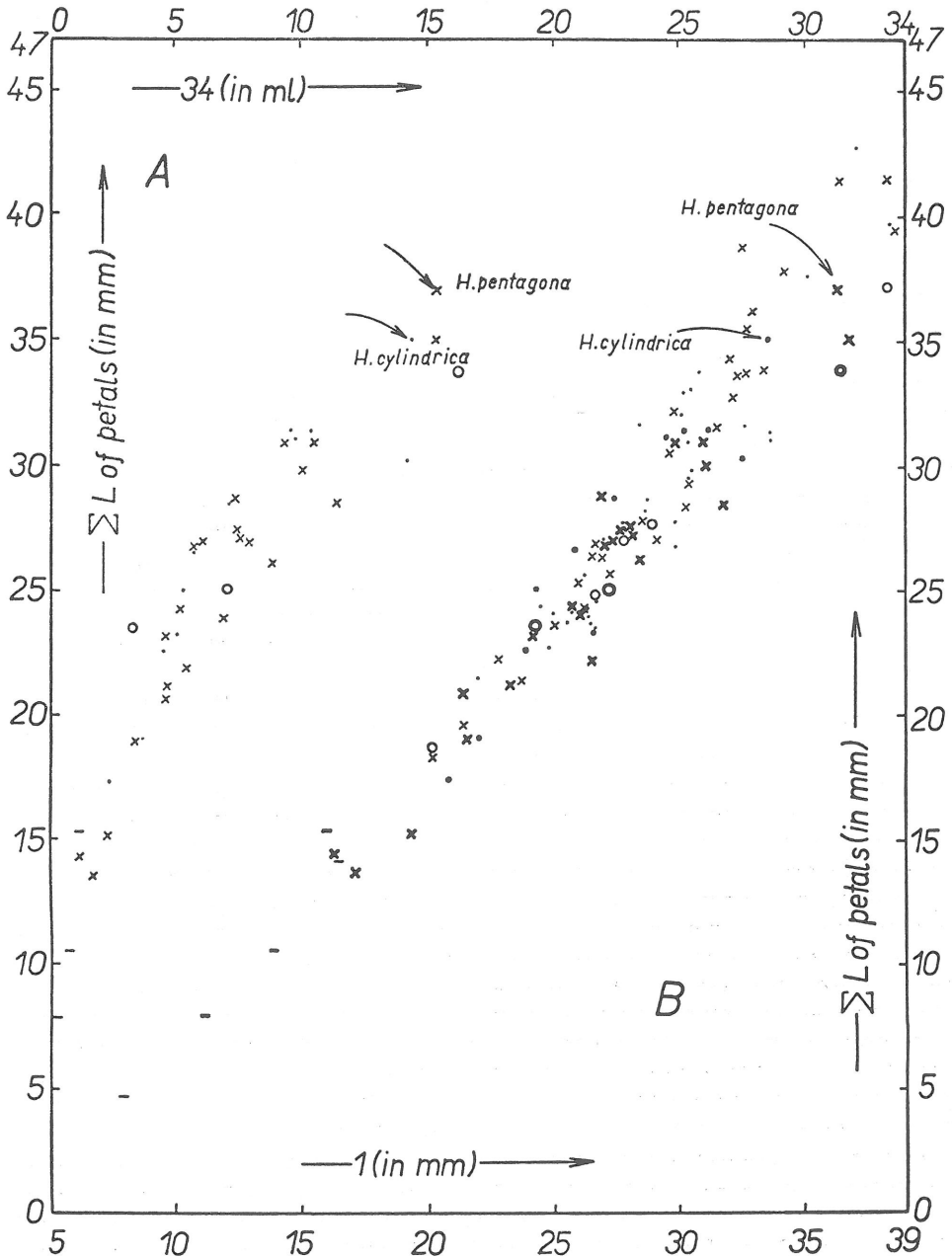

Fig. 11 — A — Volume of test [34] relative to the sum of petal lengths (5+6+7) in *H. alta*. B — Length of test [1] relative to the sum of petal lengths (5+6+7) in *H. alta*. Specimens with measured volume of test designated by large points and strong crosses. Probable sexes in both A and B designated as in text-fig. 2.

larger, others with smaller pores. Apical system flat or slightly convex, distance of its center from anterior margin of test 49.9 (37.7 mm)—54.0 (36.5 mm) percent L, \bar{x} = 51.7 percent (N = 12).

Ambulacra: Petals well developed, flush or slightly inflated, open distally. Petal III mostly the longest or of the same length as petal I (V), its length 33.6 (32.7 mm)—39.9 (35.6 mm) percent L, \bar{x} = 36.7 percent (N = 10). Relative length from the sum of lengths of I (V), II (IV), and III is from 33.9 (holotype) to 35.2 percent L (N = 9). Width 12.5 (32.7 mm)—16.9 (35.6 mm) percent L, \bar{x} = 15.0 percent (N = 10), width of interporiferous zones 43.1 (43.2 mm)—68.8 (36.2 mm) percent of petal width, \bar{x} = 53.1 percent (N = 10), interporiferous zone therefore approximately twice to four times wider than one poriferous zone. Pores in porepairs strongly conjugate, of the same type as in *H. alta* (see above). For numbers of porepairs see tab. 2.

Anterior paired petals (II, IV) shortest, their length 30.0 (32.7 mm)—38.2 (37.7 mm) percent L, \bar{x} = 33.3 percent (N = 11). Relative length from the sum of lengths of I (V), II (IV), and III is from 30.2 to 32.3 (holotype) percent L (N = 9). Width 13.1 (32.7 mm)—16.9 (35.6 mm) percent L, \bar{x} = 15.0 percent (N = 11), width of interporiferous zones 44.2 (32.7 mm)—67.3 (36.2 mm) percent of petal width, \bar{x} = 54.5 percent (N = 11), interporiferous zone width therefore the same as in petal III (see above). Angle made by petal and plane of symmetry (measured anteriorly) 65.0 (32.0 mm)—71.1° (26.0 mm), \bar{x} = 68.9° (N = 11), distance of petal ends 66.4 (32.7 mm)—77.5 (35.6 mm) percent L, \bar{x} = 63.7 percent (N = 9), distance of line joining distal ends of petals from anterior margin of test 28.4 (35.6 mm)—37.0 (43.2 mm) percent L, \bar{x} = 33.1 percent (N = 11). Pores in porepairs identical with those of petal III, their numbers in some specimens see tab. 2.

Posterior paired petals (I, V) often of the same length as petal III, their length 33.6 (32.7 mm)—43.5 (37.7 mm) percent L, \bar{x} = 36.9 percent (N = 10). Relative length from the sum of lengths of I (V), II (IV), and III 33.7—34.7 percent (N = 9). Width 13.3 (32.7 mm)—17.2 (32.8 mm) percent L, \bar{x} = 15.5 percent (N = 11), width of interporiferous zones 43.2 (32.7 mm)—67.3 (36.2 mm) percent of petal width, \bar{x} = 52.9 percent (N = 11), interporiferous zones therefore as wide as in other petals. Angle made by petal and plane of symmetry (measured posteriorly) 33.0 (37.4 mm)—37.0° (32.0 mm), \bar{x} = 35.0° (N = 10), distance of petal ends 30.1 (36.5 mm)—60.1 (35.6 mm) percent L, \bar{x} = 51.3 percent (N = 10), distance of line joining ends of petals from posterior margin of test 8.6 (33.8 mm)—14.6 (37.7 mm) percent L, \bar{x} = 12.6 percent (N = 11). Pores as in other petals, their numbers see tab. 2.

Ambulacra beyond petals of the same width and direction as in *H. alta*. Demiplates close to petal ends and peristome are single, in contact or separated by primaries. In other parts of all petals many triads of small plates (two demiplates and one included plate), in paired petals and mainly in I and V also more complex groups with five members. Composition of ambulacra most complex beyond ambitus in I and V. In other petals some triads separated by primaries. Pore zones very narrow, flush or deepened, interporiferous zones very wide, slightly inflated. Pores often hardly countable owing to bad preservation and the too complex

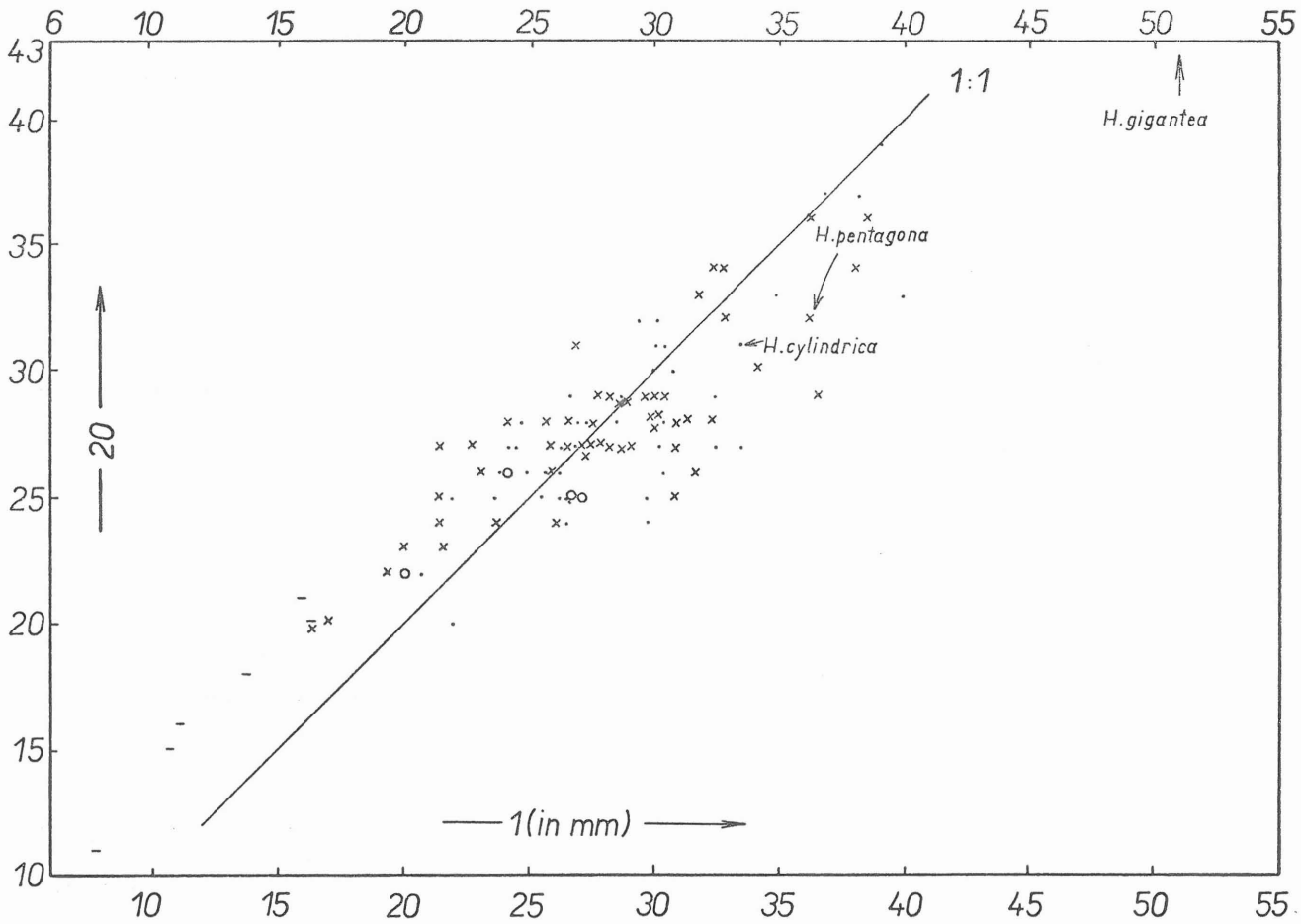

Fig. 12 — Number of porepairs in a single poriferous zone in petal III [20] relative to the length [1] in *H. alta*. Sexes as in text-fig. 2.

structure. In one zone of ambulacrum III about 108 (26.0 mm)—147 (32.0 mm) pores (N = 3), in II/IV about 121 (32.6 mm)—153 (32.0 mm) pores (N = 4), in I (V) about 146 (33.8 mm)—156 (32.0 mm) pores (N = 2). In one column of ambulacrum III about 63 (32.7 mm) (N = 1), in II (IV) 49 (33.8 mm) to about 55 (32.0 mm) (N = 3), and in I (V) 50 (32.0 mm) to about 53 (32.7 mm) (N = 3) primary plates. Buccal pores distinct rarely in well preserved specimens.

I n t e r a m b u l a c r a : Number of plates see tab. 2. The distal end of petal I (V) is bordered by plates 10, 11 and 11, 11 in 1a and 5b (or in 4b, 5a) (N = 2), the end of petal II (IV) is bordered by plates 11, 12 and 12, 12 in 1b and 2a or in 3b and 4a (N = 2), the end of petal III by plates 12, 14 (counted from peristome) in 2b and 3a (N = 1).

P e r i s t o m e : Central to slightly anterior, bourrelets only little developed. Peristome small, pentagonal or roundedly pentagonal in outline, only slightly depressed into ventral part of test. Sphaeridia in double rows ill defined.

P e r i p r o c t : Inframarginal, transversely elongated, moderately sharpened anteriorly, from posterior margin of test distant 15.0 (26.0 mm)—21.2 (37.7 mm) percent L, \bar{x} = 18.8 percent (N = 12). Transverse diameter (width) 9.1 (37.4 mm)—12.8 (32.7 mm) percent L [the only specimen up to about 14.0 (35.6 mm) percent L], \bar{x} = 10.6 percent (N = 9). Periproct bordered in 5a and 5b by plates 4, 5, 6 and 5, 6 in one specimen, by plates 4, 5, 6 on both sides in other.

T u b e r c u l a t i o n : The same as in *H. alta* (see above).

V o l u m e o f t e s t : In the only measured test, the holotype, 10.2 ml (length of test 32.0 mm, other dimensions see tab. 2).

R e m a r k s a n d r e l a t i o n s : *H. subcylindrica* belongs to the

5a \ 5b	4, 5	4, 5, 6	5, 6	5, 6, 7	6, 7
4, 5	—	—	—	1	—
4, 5, 6	2	1	6	2	—
5, 6	3	—	9	4	1
5, 6, 7	—	1	3	—	—
6, 7	—	—	—	1	—

Fig. 13 — Distribution of interambulacral plates in 5a and 5b bordering the periproct in *H. alta* (N=34).

group of species with more or less circular and low test, extending geographically from the Americas as far as western Africa. Besides *H. subcylindrica* there are other 2—3 species in this group: *H. rutteni* (PIJPERS, 1933) (syn. *Bonaireaster*) from the Middle Eocene of Bonaire (Netherlands Antilles), *H. meunieri* (LAMBERT, 1907) from the Middle Eocene of Senegal, and *H. lata* (ARNOLD et H. L. CLARK, 1927) from the Middle Eocene of Jamaica belong here at first sight. *H. rotunda* (ARNOLD et H. L. CLARK, 1927) and *H. rugosa* (ARNOLD et H. L. CLARK, 1927), on the other hand, have a circular test but differ in other features (large peristome and bourrelets, periproct posterior, single demiplates beyond petals). These two species may be conspecific (Kier 1967a), but they seem to belong rather in the group near to *H. alta*.

A rich material of *H. rutteni* (306 specimens) from Bonaire has recently been studied by Kier (op. cit.). The width of their tests is 88.0—95.0 percent L, height 40.0—50.0 percent L. *H. rutteni* is thus lower than *H. subcylindrica* (see description and tab. 2). Interporiferous zones are narrower than one poriferous zone and more inflated than in *H. subcylindrica*. Ambulacra beyond petals are very complex and rich in demiplates and included plates in *H. rutteni*. Primary plates are occluded. This structure (see Kier op. cit., fig. 47C) is similar to *H. subcylindrica* from Loma Caoba, but the latter species is more complex, having groups of five small plates on adradial suture (text-figs. 17 B—G, 18 A—C).

H. meunieri from Senegal was also revised by Kier (op. cit.), but only five specimens are known. Their width is 91.0—93.0 percent L, height 39.0—50.0 percent L, interporiferous zones inflated, narrower than one poriferous. Structure of ambulacra beyond petals indistinct, but the “large number of pores near ambitus indicates included plates” (Kier op. cit., p. 116). *H. meunieri* is very similar to *H. rutteni* and the identity of the two species is possible. Nevertheless, more specimens of *H. meunieri* are needed for such a conclusion (Kier op. cit.).

H. subcylindrica differs from the two species by more anterior periproct, very wide interporiferous zones of petals and more complex pattern of demiplates and included plates.

H. subcylindrica is macromorphologically nearest to the holotype of *H. lata* (ARNOLD et H. L. CLARK) from Jamaica. Dimensions of this specimen derived from photographs in Kier (op. cit., pl. 33, figs. 3—5) are as follows: Length (= L) about 35.0 mm, width about 88.6 percent L, height about 45.7 percent L, distance of periproct from the posterior margin of test about 22.9 percent L, porepairs in one zone of petal V (b) about 31, II (b) about 34, III (a) about 39 porepairs. [Dimensions of this specimen given by Arnold and H. L. Clark (1927, p. 35): Length (= L) 33.5 mm, width about 89.6 percent L, center of periproct from posterior margin of test 26.9 percent L. Distance of aboral margin of periproct from posterior margin of test counted by me as 23.1 percent L]. A specimen of *H. subcylindrica* with nearly identical dimensions (No. 6101) see tab. 2. While holotype of *H. lata* appears to be very similar, paratypes are considerably different from *H. subcylindrica*. Their periproct is located more posteriorly, which agrees well with the position in *H. ovumserpentis* (GUPPY). Location of periproct in holotype is, on the contrary, more anterior than in most specimens of *H. ovumserpentis*. Regarding the great

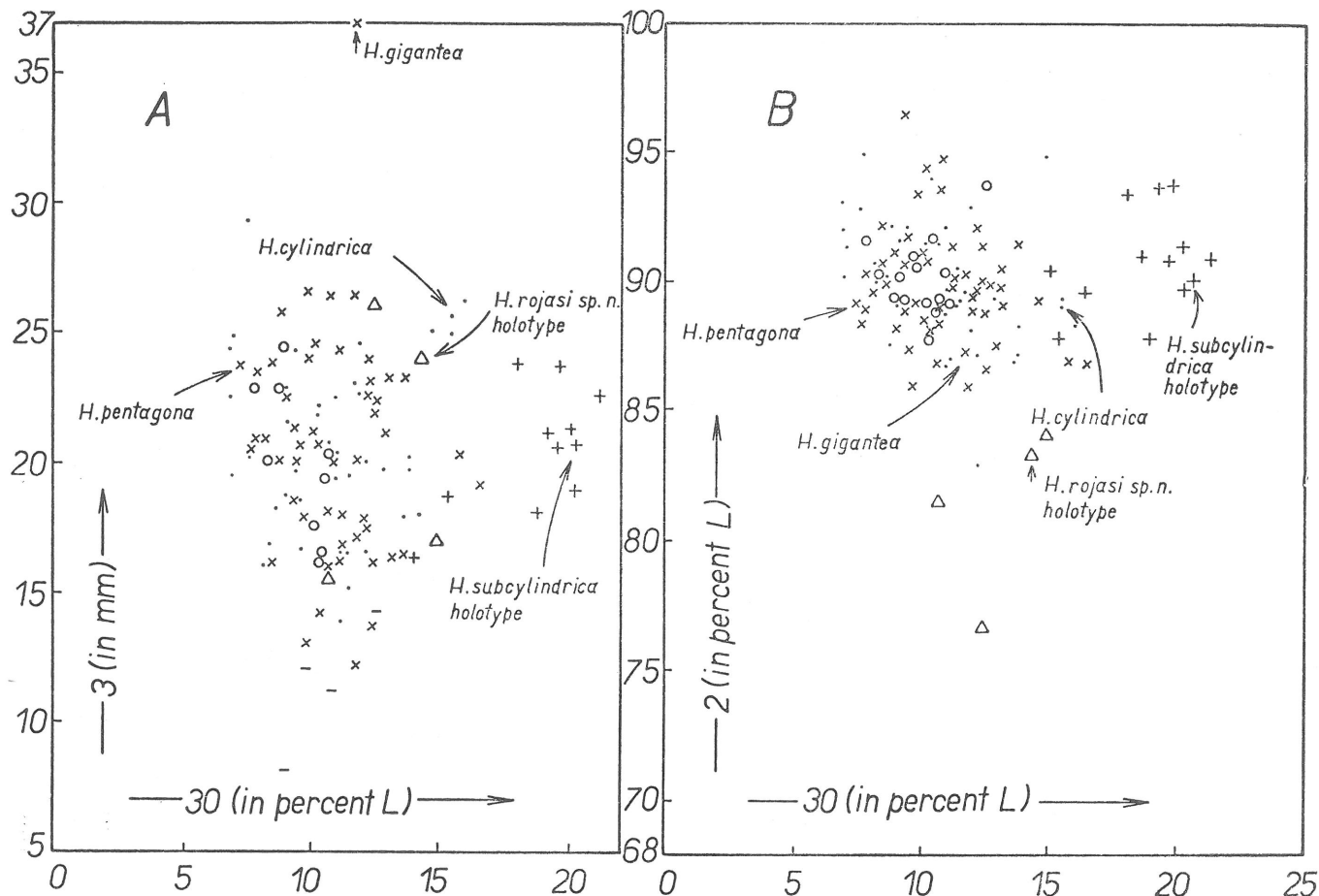

Fig. 14 — A — Height of test (3) relative to the location of periproct (30) in percent L in *H. alta*, *H. subcylindrica*, and *H. rojasi* sp. n. B — Width of test (2) in percent L relative to the location of periproct (30) in percent L in *H. alta*, *H. subcylindrica*, and *H. rojasi* sp. n. Designation of sexes and species as in text-fig. 2.

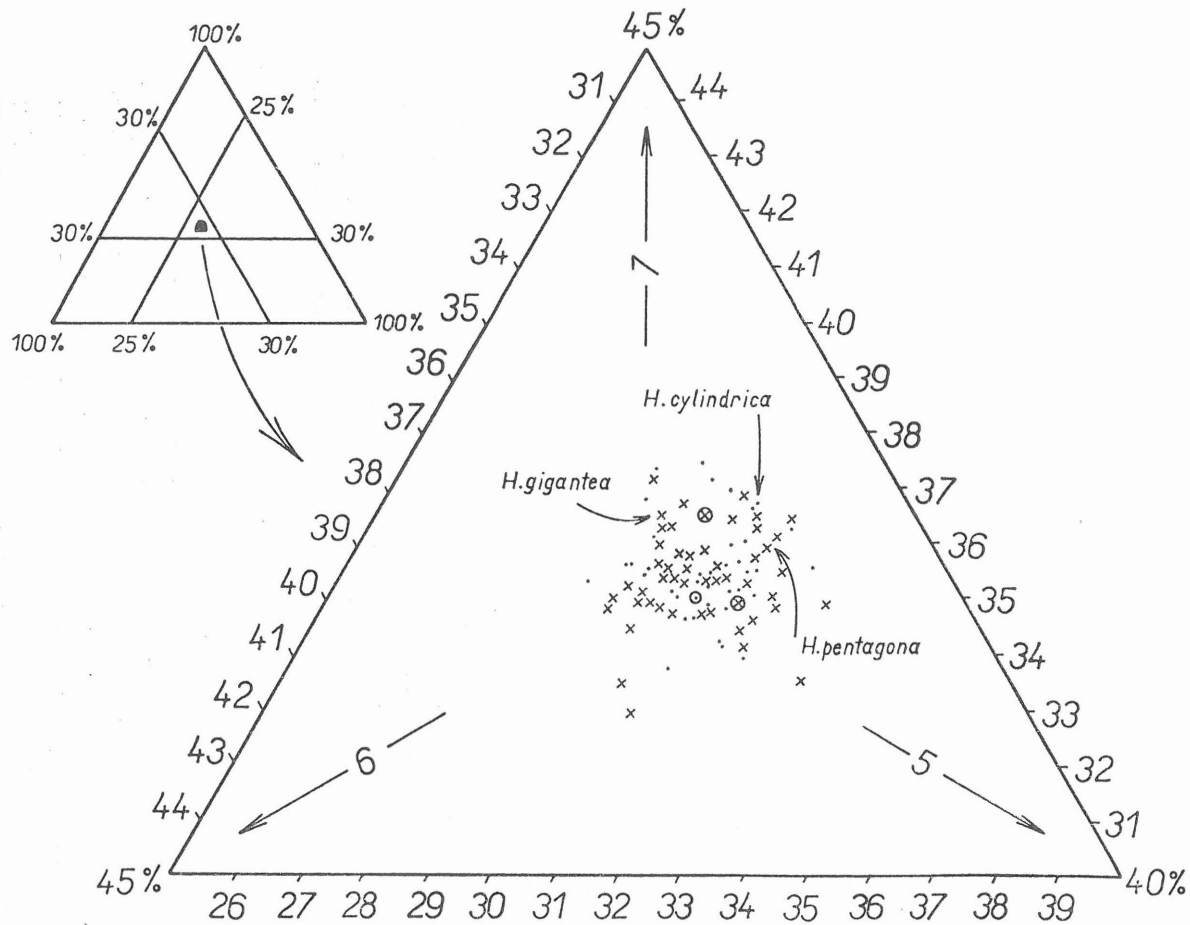

Fig. 15 — Relation of petal lengths in *H. alta*. Only one petal of pair in paired petals plus petal III are considered. 5- length of petal II [IV], 6- length of petal I [V]. 7- length of petal III. Sexes as in text-fig. 2. Symbols in circles — more specimens.

variation in the position of periproct in *H. ovumserpentis*, the holotype of *H. lata* was conspecificed with it. In my opinion, the holotype may represent an independent species, differentiated enough from *H. ovumserpentis* (*H. ovumserpentis* has well developed bourrelets and a large peristome, see Kier op. cit., pl. 34, figs. 2, 5 — lectotype and paralectotype). Relation of *H. lata* to *H. subcylindrica* seems to be very close, but they cannot be considered as one species, because there are in *H. lata* very simple ambulacra beyond the petals, with single demiplates only.

Haimea sp.

Pl. 6, fig. 8; pl. 7, figs. 1—3; pl. 8, figs. 4—8

Horizon and locality: Middle Eocene, Canteras de Caraballo, Loma Caoba, San Diego de los Baños, Pinar del Río province, Cuba.

Material: Five specimens (Nos. 4415, 4622, 6266, 6274, 8202) well preserved and one abnormal (No. 8148), all derived from new collections made by the author. They are deposited in the Geological and Paleontological Institute of the Academy of Sciences of Cuba in Havana.

DESCRIPTION

Shape and size: Length (= L) 16.0—37.2 mm, \bar{x} = 26.4 (N = 5). Test elongated, width 79.0 (26.2 mm)—84.4 (16.0 mm) percent L, \bar{x} = 81.2 percent (N = 5), maximum width at the level of apical system or slightly posterior or anterior. Height 56.5 (30.6 mm)—62.6 (37.2 mm) percent L, \bar{x} = 59.6 percent (N = 4), maximum height at apex or slightly anterior. Test rounded to slightly pentagonal in outline. Dorsal side flat, only a little swollen anterior to peristome.

Apical system: Monobasal, four genital pores as in preceding species. Distance from anterior margin of test 51.1 (26.2 mm)—56.3 (16.0 mm) percent L, \bar{x} = 53.7 percent (N = 5).

Ambulacra: Petals well developed, inflated, open distally. Petal III longest, its length 35.9 (30.6 mm)—42.5 (16.0 mm) percent L, \bar{x} = 39.3 percent (N = 5), width 14.5 (26.2 mm)—18.1 (16.0 mm) percent L, \bar{x} = 16.6 percent (N = 4). Width of interporiferous zones 31.6 (26.2 mm)—18.1 (16.0 mm) percent L, \bar{x} = 16.6 percent (N = 4). Width of interporiferous zones 31.6 (26.2 mm)—48.3 (16.0 mm) percent of petal width, \bar{x} = 41.3 percent (N = 4), interporiferous zones therefore ca. 0.9—1.6 times wider than one poriferous. Poriferous zones slightly elevated perradially, interporiferous zones distinctly inflated. Pores in porepairs as in preceding species. Number of pores see tab. 2.

Anterior paired petals (II, IV) shortest, their length 26.3 (16.0 mm)—33.8 (22.2 mm) percent L, \bar{x} = 30.6 percent (N = 5). Width of interporiferous zones approaching closely that in petal III (see above). Number of porepairs see tab. 2. Angle made by petal and plane of symmetry (measured anteriorly) 65.0 (26.2 mm)—71.0° (37.2 mm), \bar{x} = 67.6° (N = 4), distance of distal ends of petals 63.1 (22.2 mm)—66.8 (26.2 mm) percent L, \bar{x} = 65.2 percent (N = 4), distance of line joining ends of petals from anterior margin of test 31.3 (26.2 mm)—37.5 (16.0 mm) percent L, \bar{x} = 34.6 percent (N = 5).

Length of posterior paired petals (I, V) 33.1 (16.0 mm)—38.3 (22.2 mm) percent L, \bar{x} = 36.4 percent (N = 5), width 15.1 (37.2 mm)—18.1

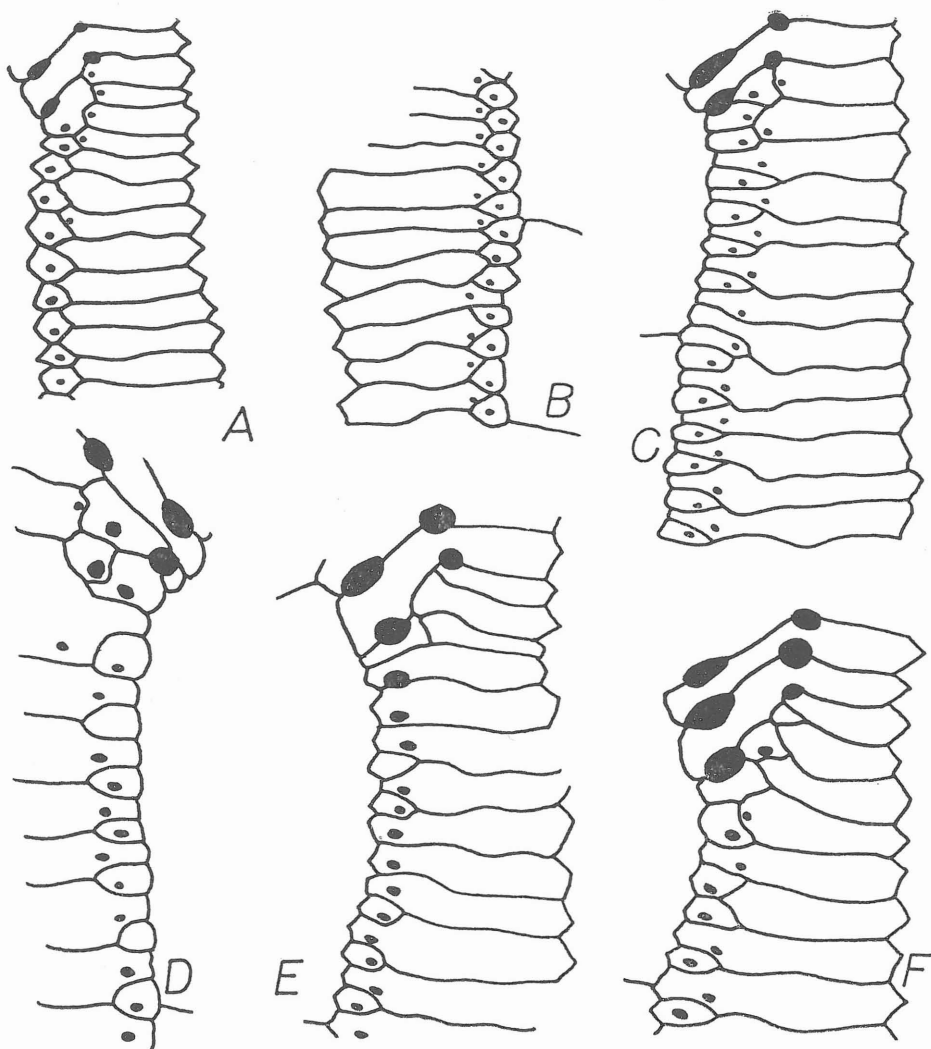

Fig. 16 — A — Plate arrangement in half-ambulacrum Va beyond the petal in *H. alta*, No. 4431. x 14.0. B — Ditto in Vb at the level of periproct of the same specimen. x 14.0. C — Ditto in IVa beyond the petal of *H. sp.* No. 6266. x 14.9. D — Ditto in IIIb beyond the petal of *H. gigantea* (holotype). No. 4270. x 15.0. E — Ditto in IIa beyond the petal of *H. pentagona* (holotype). No. 4244. x 15.0. F — Ditto in IVa beyond the petal of the same specimen. x 14.9.

(16.0 mm) percent L, \bar{x} = 16.6 percent (N = 5). Width of interporiferous zones, structure of porepairs and convexity of petals of similar values as in the other petals. Number of pores see tab. 2. Angle made by petal and plane of symmetry [measured posteriorly] 30.0 [22.2 mm]—35.0° [26.2 mm], \bar{x} = 32.4° (N = 5), distance of petal ends 49.0 [30.6 mm]—52.7 [26.2 mm] percent L, \bar{x} = 50.6 percent (N = 3), distance of line joining

ends of petals from posterior margin of test 7.2 (22.2 mm)—12.7 (30.6 mm) percent L, \bar{x} = 10.0 percent (N = 5).

Ambulacra beyond petals as in *H. alta*, composed of primary plates and demiplates on adradial suture. Demiplates if well preserved in contact or only slightly separated by primaries (text-figs. 16C, 17A). No groups of demiplates, no included plates. Poriferous zones very narrow, interporiferous wide, as in *H. alta*. Number of ambulacral pores and primary plates see tab. 2. Buccal pores distinct.

Interambulacra: Complete number of plates observed in the only specimen, see tab. 2. Distal end of petal I (in 1a and 5b) is bordered by plates 11, 12, end of petal II (in 1b and 2a) by plates 10 to 12, end of petal III (in 2b and 3a) by plates 12 and 11 (all counted from peristome).

Peristome: Subcentral to slightly posterior, bourrelets little developed. Peristome pentagonal in outline, small, similar to *H. subcylindrica*. Sphaeridia present, ill preserved.

Periproct: Inframarginal, transversely elongated, distance from posterior margin of test 12.2 (26.2 mm)—17.1 (22.2 mm) percent L, \bar{x} = 13.6 percent (N = 5). Diameter 11 percent L in specimen No. 6266 (L = 30.6 mm). In the same specimen periproct bordered (in 5a and 5b) by plates 5 and 6.

Remarks and relations: Specimens described above are similar to *H. alta* only superficially and many features distinguish them easily. The test of *H. sp.* is longer and lower, its petals are inflated, interporiferous zones narrow, peristome small and bourrelets indistinct. Also the pores beyond petals appear to be fewer, being nearly of the same number in all ambulacra (last feature observed, however, in the only specimen — see tab. 2). The periproct of *H. sp.* is relatively more anterior.

H. sp. differs from *H. ovumserpentis* mainly in having inflated, shorter and distally more closed petals.

H. sp. also resembles other species in some details. From *H. platypetala* (ARNOLD et H. L. CLARK, 1927) provisionally synonymised by Kier (op. cit.) with *H. ovumserpentis* it differs in having inflated petals and lower test, from *H. stenopetala* (ARNOLD et H. L. CLARK) by its simple structure of ambulacra beyond petals. Both *H. platypetala* and *H. stenopetala*, however, are little known, as only strongly weathered holotypes were described from the Middle Eocene of Jamaica.

Haimea rojasi sp. n.

Pl. 8, figs. 1—3

? 1924 *Echinolampas ovum serpentis*. GUPPY. — Sánchez Roig, p. 31

? 1926 *Oligopygus ovum serpentis*. GUPPY. — Sánchez Roig, p. 80—81

1932 *Pauropygus ovum-serpentis* [GUPPY]. — Lambert, p. 293, pl. 17, fig. 13

1949 *Pauropygus ovum-serpentis*, GUPPY. — Sánchez Roig, p. 167—168

Holotype: Specimen figured in this paper, pl. 8, figs. 1—3, No. 6915, deposited in the collections of the Geological and Paleontological Institute of the Academy of Sciences of Cuba in Havana.

Type horizon and locality: Eocene, according to Sánchez

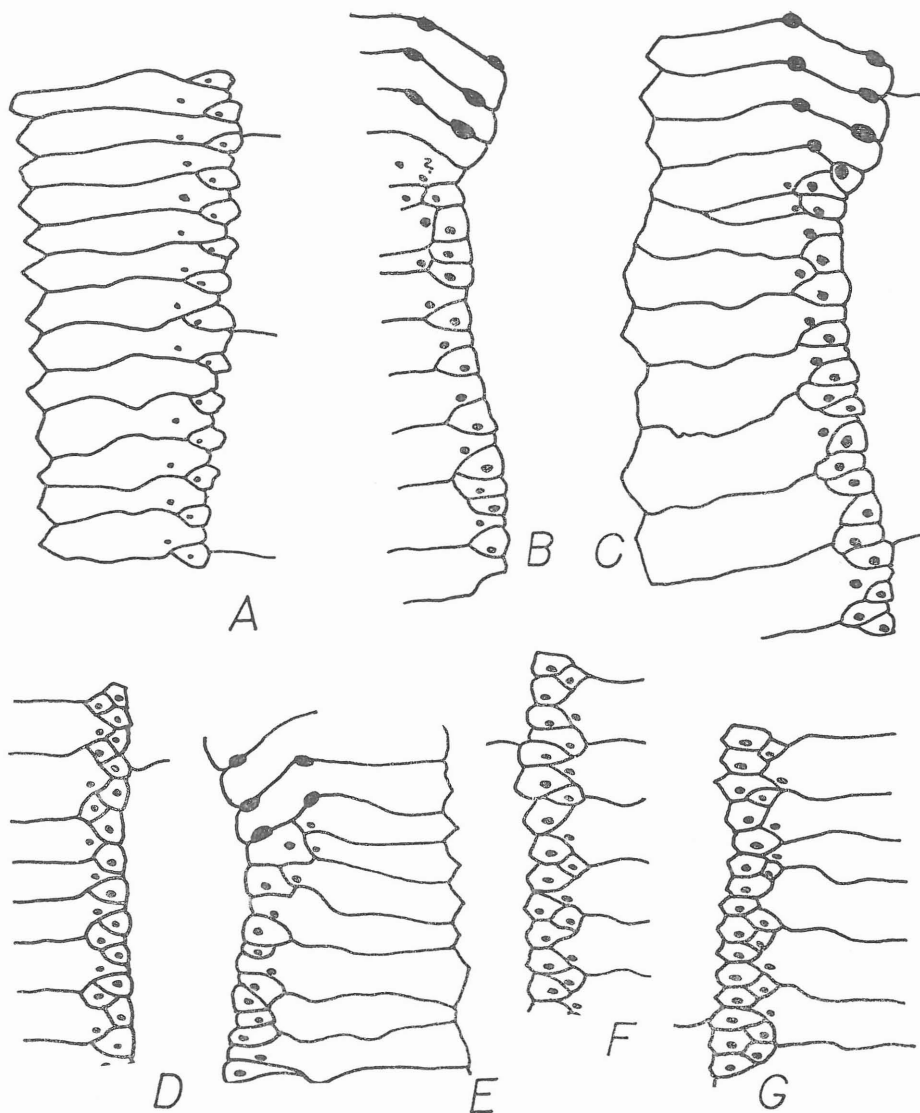

Fig. 17 — A — Plate arrangement in half-ambulacrum Vb at the level of periproct of *H.* sp. No. 6266. x 15.0. B — Ditto in IIIb beyond the petal of *H. subcylindrica* (holotype). No. 4195. x 15.0. C — Ditto in IVb beyond the petal of the same specimen. x 15.0. D — Ditto in IIIb beyond the ambitus of the same specimen. x 14.0. E — Ditto in Va beyond the petal of the same specimen. x 14.5. F — Ditto in Va at the ambitus of the same specimen. x 14.5. G — Ditto in Va beyond the ambitus as far as the level of periproct (bottom of the figure) of the same specimen. x 14.5.

Roig (1949), Late Eocene according to Brodermann (1949), Alcalá y Báguanos, Holguín. Collector was designed on the original label: "Colectado por Ruiz Comesañas, Juez de Instrucción, Holguín" (in Sánchez Roig 1926, p. 4 Dr. Gaston Ruiz is mentioned as the collector and in 1949, p. 168, Ruiz Comesañas, Collector).

Material: In addition to the holotype other 3 specimens, Nos. 5542, 5543 and 6913. Specimens Nos. 5542 and 5543 (old numbers in ink on tests 661, 662) are derived from the Eocene, Sancti Spiritus, Santa Clara, Specimen No. 6913 comes from the Eocene Finca La Rabona, frente al cojo, Hda Cacarrates, Barrio Tamarindo, Morón, Camagüey.

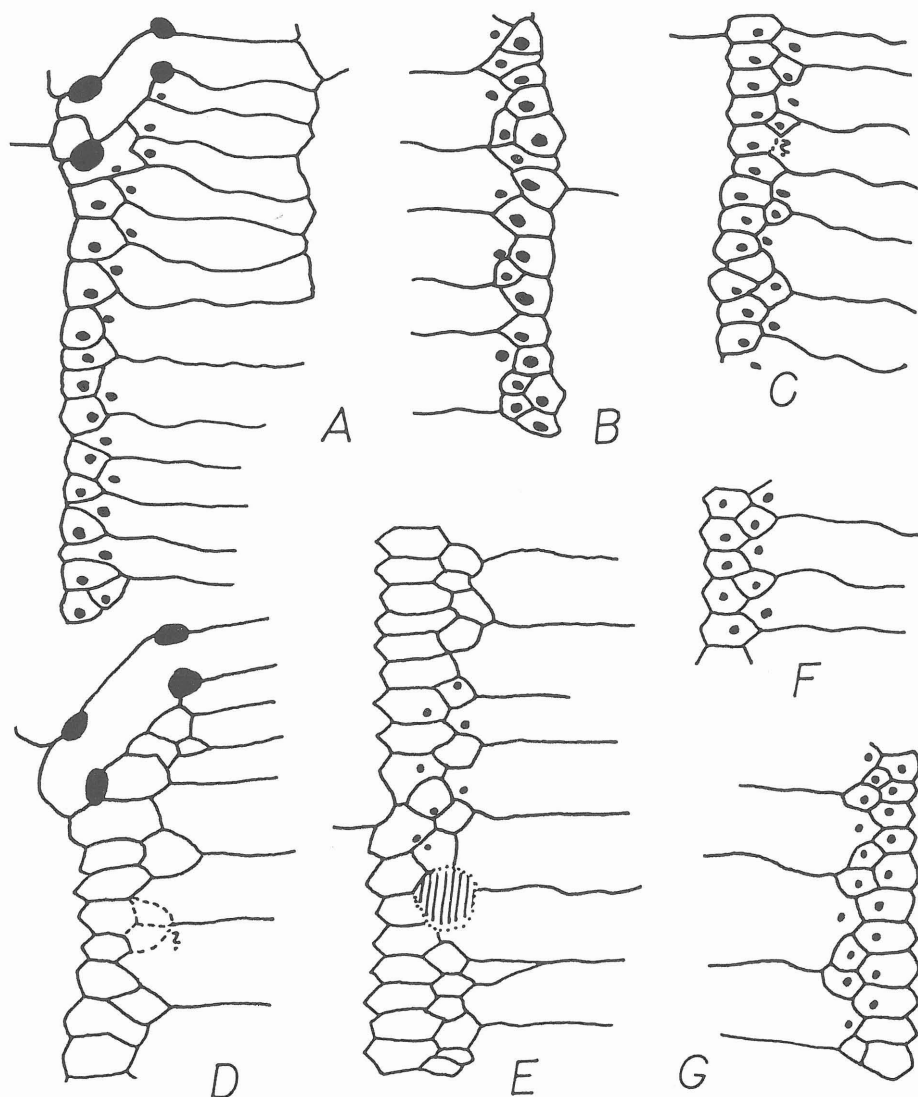

Fig. 18 — A — Plate arrangement in half-ambulacrum Ia beyond the petal in *H. subcylindrica*, No. 4596. x 14.5. B — Ditto in Iib beyond the ambitus of the same specimen. x 14.5. C — Ditto in Ib at the level of periproct of the same specimen. x 14.0. D — Ditto in IVa beyond the petal of *H. rojasi* sp. n. (holotype). No. 6915. x 15.0. E — Ditto in Va at the ambitus of the same specimen. x 15.0. F — Ditto in IVa beyond the ambitus of *H. rojasi* sp. n. No. 5542. x 14.5. G — Ditto in IIIb beyond the ambitus of the same specimen. x 14.5.

Derivation of name: *rojasi* — a name written in pencil on the back side of the label of specimen No. 6913, probably by the hand of Sánchez Roig. This specimen was very probably sent to Sánchez Roig by its collector, Dr. Raúl Rojas from Morón with a request for determination (see the words "Espero su clasificacion", written on the back side of the label by the same handwriting as the localisation on the face.

DESCRIPTION

Shape and size: Length (= L) 33.6—56.0 mm (holotype 45.0 mm, No. 5542 — 36.8 mm, No. 5543 — 33.6 mm, No. 6913 — 56.0 mm), \bar{x} = 42.9 (N = 4). Test elongated, width 76.8 (56.0 mm)—84.2 (36.8 mm) percent L, \bar{x} = 81.5 percent (N = 4), maximum width at the level of apex. Height of test 46.2 (36.8 mm)—54.7 (45.0 mm) percent L, \bar{x} = 48.4 percent (N = 4), maximum height in apex or slightly anteriorly. Test rounded in outline, all specimens but holotype slightly sharpened anteriorly (holotype anteriorly damaged, see pl. 8, figs. 1, 2).

Apical system: Monobasal, four genital pores, anterior pair closer together than posterior. Holotype and specimen No. 5543 have all pores larger, specimen No. 6913 smaller and No. 5542 has no pores preserved. Apical system subcentral to central, its distance from the anterior margin of test 48.9 (45.0 mm)—53.0 (33.6 mm) percent L, \bar{x} = 50.6 percent (N = 3).

Ambulacra: Petals well developed, flat or slightly convex in interporiferous zones, distally opened.

Petal III the longest, its length 36.9 (45.0 mm)—44.6 (56.0 mm) percent L, \bar{x} = 40.5 percent (N = 3), width 10.3 (36.8 mm)—13.7 (33.6 mm) percent L, \bar{x} = 12.3 percent (N = 4), width of interporiferous zones 34.8 (33.6 mm)—42.7 (56.0 mm) percent of petal width, \bar{x} = 38.0 percent (N = 4), interporiferous zone therefore only slightly, maximum 1.5 times wider than one poriferous, but no specimen is well enough preserved in this area. Number of porepairs in one zone: 34 (holotype), 37 (No. 5543), 56 (No. 6913).

Anterior paired petals (II, IV) the shortest, their length 27.3 (45.0 mm)—34.8 (56.0 mm) percent L, \bar{x} = 30.3 percent (N = 3), width 10.3 (36.8 mm)—13.9 (56.0 mm) percent L, \bar{x} = 12.4 percent (N = 4), width of interporiferous zones 34.8 (33.6 mm)—13.9 (56.0 mm) percent L, \bar{x} = 12.4 percent (N = 4), width of interporiferous zones 34.8 (33.6 mm)—41.0 (56.0 mm) percent of petal width, \bar{x} = 37.6 percent (N = 4), relation to width of poriferous zones therefore as in petal III. Angle made by petal and plane of symmetry (measured anteriorly) 69.0° in holotype and specimen No. 5543. Distance of petal ends in holotype 56.7 percent L, distance of line joining ends of petals from the anterior margin of test in holotype 48.9 percent L. Number of porepairs in one zone: 27 (holotype), 29 (No. 5543), and 45 (No. 6913).

Length of posterior paired petals (I, V) 29.8 (33.6 mm)—38.4 (56.0 mm) percent L, \bar{x} = 33.4 percent (N = 3). Width of petals and interporiferous zones as in anterior petals. Angle made by petal and plane of symmetry (measured posteriorly) in holotype 33.0°, in specimen No. 5543 — 31.0°, distance of petal ends in holotype 43.6 percent L, distance of line joining petal ends from posterior margin of test in holotype 15.6

percent L. Number of porepairs in one zone: 34 (holotype), 30 (No. 5543), 47 (No. 6913).

Ambulacra beyond petals of the same width or wider than petals. Their course and direction similar to those in *H. alta* (see above). Poriferous

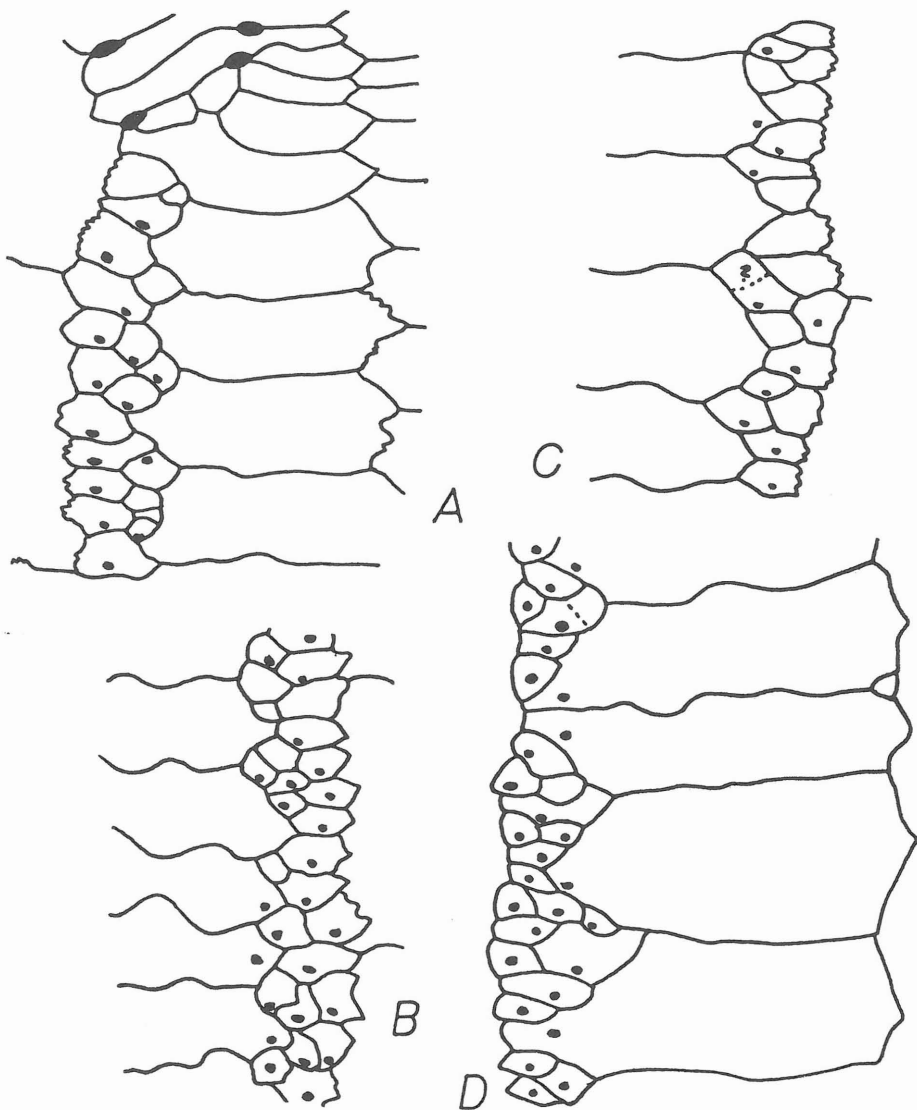

Fig. 19 — A — Plate arrangement in half-ambulacrum IIa beyond the petal of *Oligopygus sanchezi*, probably from the Late Eocene, Finca Turibacoa de Pedro Mesa, Barrio Majagua, Ciego de Avila, Camagüey. No. 6601. x 15.0. B — Ditto in IIb at the ambitus of the same specimen. x 15.0. C — Ditto in Ib at the ambitus of *Oligopygus sanjosephi* (holotype). No. 4143. x 14.5. D — Ditto in Va at the ambitus of *O. cf. cubensis*. No. 5038. x 15.0.

zones narrow, pores in large number arranged in double rows. Sutures between plates usually visible only in some parts. Small plates on adradial suture distinctly arranged in groups of five, composed of three demiplates and two included plates (see specimen No. 5542 in text-fig. 18G). Immediately beyond petal IV, groups of three to four small plates with one included are present, primaries being occluded (see holotype in text-fig. 18D). In specimen No. 5542 beyond ambitus in IVA, triads of plates with one included, primaries being occluded (see text-fig. 18F). At ambitus of ambulacra I and V, structure most complex with groups of

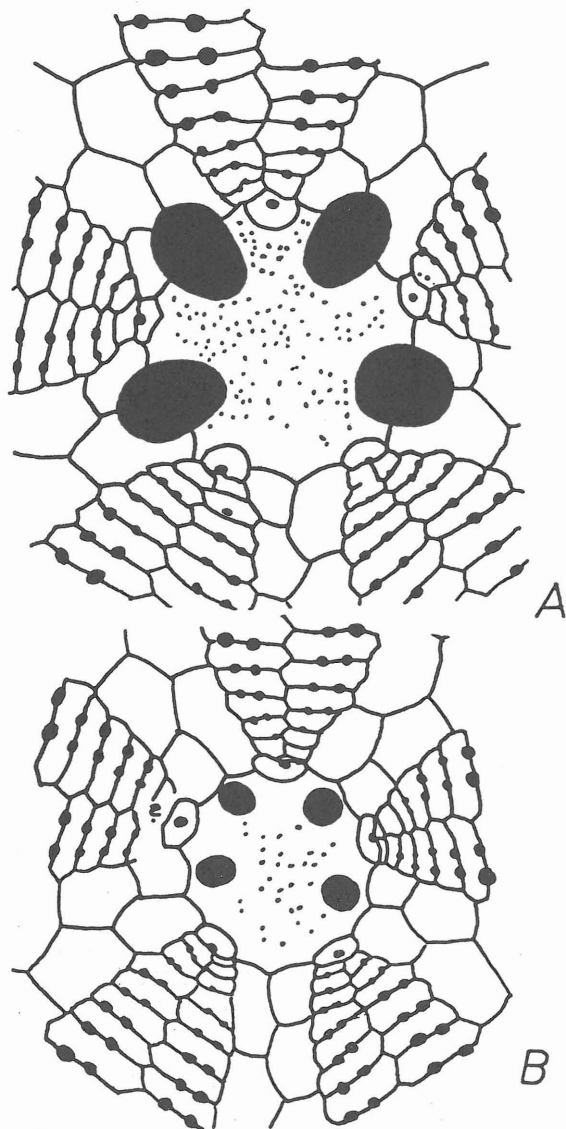

Fig. 20 — Female (A) and male (B) apical systems in *H. alta* (A — No. 6035, B — No. 6209). $\times 15.0$.

three to five and possibly more small plates (see holotype, text-fig. 18E). Number of primary plates: in IIa about 53, Ib about 57, in IIIa about 48 plates [No. 5543].

Interambulacra: In 2a — 17 plates, in 5b — 18 plates [No. 5543].

Peristome: Subcentral, pentagonal, bourrelets well developed (see pl. 8, fig. 2). Sphaeridia not preserved.

Periproct: Inframarginal, slightly transversely elongated to nearly circular. Its size influenced by weathering. Distance from posterior margin of test about 10.7 [33.6 mm]—14.9 [36.8 mm] percent L, \bar{x} = about 13.1 percent (N = 4). In specimen No. 5543 bordered in 5a by plates 6 and 7, in 5b by plates 4 to 6.

Tuberculation: Only in holotype sufficiently distinct in peristomial region. It seems to be of the same type as e.g. in *H. alta*.

Remarks and relations: The series studied is macromorphologically closest to *H. ovumserpentis* (GUPPY) from Trinidad (Late Eocene, San Fernando Formation). This species was revised by Kier (1967a, p. 121—126) on the basis of lectotype and 6 paralectotypes. In spite of great variability of the material (see Kier op. cit., pl. 34, figs. 1—5), all specimens have only single demiplates alternating with primaries on the adradial suture beyond the petals. *H. lata* (ARNOLD et H. L. CLARK) from Jamaica is also by Kier classified with *H. ovumserpentis* (see above, discussion of *H. subcylindrica* relatives). This author mentioned *H. ovumserpentis* (op. cit.) also from Cuba (Alcalá y Báguanos, Holguín; Sancti Spíritus, Santa Clara) on the basis of Sánchez Roig's data (1949, p. 168). Sánchez Roig in his older paper (1926, p. 81) yet mentioned the localities Loma de Calisto, Nuevitas, and Los Háticos, Holguín, but no specimen from them was found in Havana. I have found only the specimens from Sancti Spíritus and Alcalá y Báguanos, described above, and a specimen from La Rabona, Morón.

As noted above, the material studied closely approaches *H. ovumserpentis* in the habitus of test, but the different structure of ambulacra beyond petals distinguishes them clearly. The existence of the new species described here on the basis of the old *H. ovumserpentis* specimens, does not imply that the latter is completely lacking in the Eocene of Cuba. It is yet probable that the specimens from Sancti Spíritus and Alcalá y Báguanos were originally more numerous and *H. ovumserpentis* was included. Of the same character could have been the recently missing material from Loma Calisto and Los Háticos. The main problem of *H. ovumserpentis* in Cuba arises from Sánchez Roig's very inadequate description and from the scarcity of new collections.

H. rojasi sp. n. is, by no means, the most complex species of the genus as concerns the structure of ambulacra beyond petals. *Haimea rojasi* sp. n. closely enough approaches a very complex ambulacral structure of some species of *Oligopygus* (compare Kier op. cit., e.g. *O. wetherbyi* LORIOLE in fig. 26, *O. zyndeli* JEANNET in fig. 28; in this paper see text-figs. 19A—D with *Oligopygus sanchezi*, *O. cf. cubensis* and especially *O. sanjosephi* from Cuba, last species with most complex groupings of small plates on adradial suture known up to the present).

Table 2

Principal values of some selected specimens of *H. subcylindrica*, *H. sp.* and *H. rojasi* sp. n. (designation of values, see p. 2). Value No. 1 in mm, Nos. 2—14, 30, 31 in percent L, Nos. 15—17 in percent of petal width, Nos. 32, 33 in angle degrees, No. 34 in ml.

Species	<i>H. subcylindrica</i>				<i>H. s p.</i>				<i>H. rojasi</i> sp. n.
	6196	5951	6298	4195 holotype	6274	8202	4622	6266	6915 holotype
Designation of value									
1	32.7	33.8	26.0	32.0	26.2	22.2	37.2	30.6	45.0
2	87.8	89.6	90.4	90.0	79.0	79.3	82.5	81.0	83.3
3	57.2	64.5	62.7	64.7	—	60.4	62.6	56.5	54.7
4	50.5	53.8	51.9	50.9	51.1	53.6	53.8	53.6	48.9
5	30.0	34.0	31.2	33.8	31.3	33.8	32.3	29.4	27.3
6	33.6	39.1	35.0	35.3	37.4	38.3	37.1	35.9	32.0
7	33.6	39.6	35.0	35.3	40.8	40.1	39.8	35.9	36.9
8	66.4	72.2	70.8	69.4	66.8	c. 63.1	66.6	64.1	56.7
9	50.2	55.3	52.7	52.2	52.7	—	c. 50.0	49.0	43.6
10	14.1	8.6	12.7	13.8	12.2	7.2	10.2	12.7	15.6
11	34.9	34.3	32.7	32.2	31.3	31.5	35.2	37.3	48.9
12	13.1	15.7	13.8	15.0	14.5	16.2	15.1	16.3	11.8
13	13.5	17.2	14.6	15.3	15.6	17.1	15.1	17.0	11.8
14	12.5	16.6	14.6	14.7	14.5	17.1	—	16.7	11.8
15	44.2	52.8	61.1	58.3	28.9	44.4	39.3	44.0	37.7
16	43.2	48.3	57.9	57.1	26.8	42.1	35.7	42.3	37.7
17	43.9	50.0	57.9	57.4	31.6	42.1	—	43.1	37.7
18	27	30	26	29	27	25	33	24	27
19	30	33	28	31	30	31	41	27	34
20	29	34	28	30	35	31	38	28	34
21	—	c. 146	c. 127	153	—	—	—	113	—
22	—	—	c. 146	c. 156	—	—	—	122	—
23	—	c. 142	c. 108	148	—	—	—	113	—
24	c. 53	49	—	c. 55	c. 50	c. 57	—	56	—
25	c. 53	52	—	c. 55	c. 55	—	—	63	—
26	c. 63	—	—	—	c. 50	—	—	60	—
27	16	18	—	—	—	—	—	16	—
28	18	18	—	—	—	—	—	16	—
29	17	19	—	—	—	—	—	17	—
30	15.3	c. 16.3	15.0	20.3	12.2	17.1	13.7	12.7	14.4
31	12.8	c. 9.2	11.5	10.6	11.1	11.3	9.9	11.8	8.4
32	68	68	71	65	65	66	71	68	69
33	35	35	33	37	35	30	34	31	33
34	—	—	—	10.2	—	—	—	7.0	—

Některí oligopygoidi rodu *Haimea* Michelin (Echinoidea) z eocénu Kuby

Z významné středněeocenní kubánské lokality Loma Caoba [u San Diego de los Baños, Pinar del Río] bylo SÁNCHEZEM ROIGEM (1949, 1953) popsáno či uvedeno celkem 5 druhů rodu *Haimea* (*H. cylindrica* SÁNCHEZ ROIG, 1953, *H. pentagona* S. ROIG, 1953, *H. gigantea* S. ROIG, 1953, *H. subcylindrica* S. ROIG, 1953 a *H. alta* [ARNOLD et H. L. CLARK, 1927]). Vymezení druhů popsanych S. Roigem však bylo velmi nepřesné. Vzhledem ke značnému stratigrafickému významu oligopygoidních ježovek (střední-svrchní eocén) jež byly v poslední době zjištěny i v Evropě [Richter et Seibertz 1978], se ukázalo jako velmi potřebné provedení jejich taxonomické revize. Studium starého originálního, ale i nově [v l. 1974—75] nasbíraného materiálu jasně prokázalo, že na lokalitě Loma Caoba jsou přítomny pouze druhy *H. alta* (syn. *H. pentagona*, *H. gigantea*, *H. cylindrica* S. ROIG) a *H. subcylindrica*. Kromě toho byl zaregistrován vzácný výskyt problematického druhu *H. sp. H. alta*, vysoce v materiálu převažující, se vyskytuje masově i ve středním eocénu Jamaiky.

Studium variability bylo provedeno na celkem 34 znacích, včetně objemu schránky. Kromě jiného byla detailně sledována i charakteristika ambulaker pod petaloidy, hlavně vývoj drobných destiček na adradiální sutuře (demidestičky, inkluzní destičky), na jejichž systematický význam upozornil Kier (1967a). Zhodnocen je i výskyt primárních deformací stavby schránky.

Kromě materiálu z Loma Caoba byla provedena revize starého S. Roigova materiálu, determinovaného jako *H. ovumserpentis* [GUPPY] z eocénu východní Kuby [Alcalá y Báguanos, Holguín; Sancti Spiritus; Finca La Rabona, Morón]. Všechn nalezený materiál náleží novému druhu *H. rojasi* sp. n., význačnému dosud nejsložitější zjištěnou stavbou ambulaker pod petaloidy u rodu *Haimea* (pentády drobných destiček).

References

- ARNOLD, B. W. et CLARK, H. L. (1927): Jamaican fossil Echini; with description of new species of Cainozoic Echinoidea by Herbert L. Hawkins. — Mem. Mus. Comp. Zool., **50**, 1, 1—54. Cambridge (Mass.).
- (1934): Some additional fossil Echini from Jamaica. — Mem. Mus. Comp. Zool., **54**, 2, 139—156. Cambridge (Mass.).
- BRODERMANN, I. J. (1949): Significación estratigráfica de los equinodermos fósiles de Cuba. — In: Sánchez Roig (ed.) (1949): Los equinodermos fósiles de Cuba. — Paleont. Cubana, 1, 305—330. Havana.
- CHESHER, R. H. (1968): The systematics of sympatric species in West Indian Spatangoids: A revision of the genera *Brissopsis*, *Plethotaenia*, *Palaopneustes*, and *Saviaster*. — Stud. Tropical Oceanogr., 7. Univ. Miami Press, Coral Gables, Florida.
- (1970): Evolution in the genus *Meoma* (Echinoidea, Spatangoida) and description of a new species from Panama. — Bull. Mar. Sci., **20**, 3, 731—761. Coral Gables, Florida.
- KIER, M. P. (1967a): Revision of the Oligopygoid Echinoids. — Smiths. Misc. Coll., **152**, 2, 1—147. Washington.
- (1967b): Sexual dimorphism in an Eocene echinoid. — J. Paleont., **41**, 4, 988—933.
- (1968): Echinoids from the middle Eocene Lake-City Formation of Georgia. — Smiths. Misc. Coll., **153**, 2, 1—45. Washington.
- (1969): Sexual dimorphism in fossil Echinoids. — Internat. Union Geol. Sci., A, 1, 215—222. Stuttgart.
- LAMBERT, J. (1932): Note sur le groupe des Oligopygus, la nouvelle famille des Haimeidae, et sur quelques échinides fossiles de Cuba. — Bull. Soc. Géol. France, **5**, 1, (1931), fasc. 3—4, 289—304. Paris.
- RICHTER, D., SEIBERTZ, E. (1978): Paläontologische Bedeutung und stratigraphische Stellung einiger Echiniden aus dem Eozän-Kalk des Klokova Massivs (Atolien, Griechenland). — N. Jb. Paläont., Monatshefte, **9**, 556—566. Stuttgart.
- SÁNCHEZ ROIG, M. (1924): Revision de los equínidos fósiles cubanos. — Mem. Soc. Cubana Hist. Nat. „Felipe Poey“, **5**, 1 [reprint], 3—68. Havana.
- (1926): Los equinodermos fósiles de Cuba. — Bol. Minas, **10**, 1—185. Havana.
- (1949): Los equinodermos fósiles de Cuba. — Paleont. Cubana, **1**, 1—302. Havana.
- (1952a): Nuevos generos y especies de equinodermos fósiles cubanos. — Mem. Soc. Cubana Hist. Nat. „Felipe Poey“, **21**, 1, 1—30. Havana.

- (1952b): Nuevos generos y especies de equinoideos fosiles cubanos. — Torreia, **17**, 3—18. Havana.
- (1953a): Nuevos equinoideos fosiles de Cuba. — Anales Acad. Cienc. Med. Fis. Nat. Habana, **91**, 2, 135—176. Havana.
- (1953b): Algunos equinoideos fósiles cubanos. — Revista de Agricultura, 53—67. Havana.
- ŽíTT, J. (1981): Aguayoaster Sánchez Roig (Echinoidea) from Cuba. — Čas. Mineral. Geol. **30**, 3, 265—284. Praha.
- (1985a): Malformation or a new type of echinoid?. — Čas. Mineral. Geol., **30**, 1, 29—38. Praha.
- (1985b): Revision of Meoma (Echinoidea, Spatangoida) from Loma Caoba (Cuba, middle Eocene) with some remarks to the evolution of the group. — Čas. Mineral. Geol., **30**, 3, 265—284. Praha.

Резюме

В работе описываются морские ежи рода *Naimea* (Oligopygoida) западокубинского местонахождения Лома Каоба (Loma Caoba) среднеэоценового возраста. Индивидуальное богатство материала позволило изучение изменчивости множества морфологических признаков панцыря и вытекающее из того определение лучшей характеристики видов. Из пяти Санчезем Роигом (Sánchez Roig) описанных видов (*N. alta*, *N. cylindrica*, *N. pentagona*, *N. gigantea*, *N. subcylindrica*) присутствуют только два, *N. alta* (синонимная с *N. pentagona* *N. cylindrica* и *N. gigantea*) и *N. subcylindrica*. Они отличаются друг от друга прежде всего строением амбулакральных зон и присутствием у второго вида большего количества маленьких пластинок (demiplates) между концами петалей и перистомом. Тогда как у *N. alta* к каждой суре между примарными пластинками принадлежит одна маленькая пластинка лежащая на адрадиальной суре, *N. subcylindrica* выделяется сложными группами последних. Несколько особей описывается как *N. sp.* Интересные примарные деформации этого вида тоже описываются.

Кроме вышеупомянутых видов, старый материал, определенный как *N. ovumserpentis* верхнеэоценового возраста, ревизуется. Целиком четыре экземпляры из местонахождений Алкала ы Багуанос, Олгин (Alcalá y Báguanos, Holguín), Санти Спиритус, Санта Клара (Sancti Spiritus, Santa Clara) и Ла Рабона, Морон, Камагуей, (La Rabona, Morón, Camaguey) показали, что они принадлежат новому виду *N. rojasi* sp. n. Тогда как у *N. ovumserpentis* развиты только простые пластинки под петалами, у *N. rojasi* sp. n. самое сложное строение амбулакральных зон с группами по пяти маленьких пластинок присутствует.

EXPLANATION OF PLATES

All specimens deposited in the collections of the Geological and Paleontological Institute, Academy of Sciences of Cuba, Havana. Photographed by the author; not whitened.

Pl. 1

Figs. 1—3 *Haimea alta* (ARNOLD et H. L. CLARK) (= holotype of *H. cylindrica* SÁNCHEZ ROIG), test viewed dorsally, ventrally, and laterally [anterior part on the left]. Loma Caoba locality near San Diego de los Baños, Pinar del Río province, Cuba. No. 4220. x 1.2.

1.2.

Figs. 4—8 *H. alta* (=holotype of *H. pentagona* S. ROIG), test viewed dorsally, laterally [anterior part on the right], and ventrally. Figs. 7, 8 — enlarged views of ventral test part with different lightnings. Buccal pores partly visible. The same locality. No. 4244. x 1.2 [figs. 4—6], x ca. 4.3 [figs. 7, 8].

Pl. 2

Figs. 1—3 *H. alta* (= holotype of *H. gigantea* S. ROIG), test viewed dorsally, ventrally, and laterally [anterior part on the left]. The same locality. No. 4270. x 1.2.

Figs. 4—6 *H. alta*, test viewed dorsally, laterally [anterior part on the left], and ventrally. The same locality. No. 6129. x 1.2.

Figs. 7—9 *H. alta*, test viewed dorsally, laterally [anterior part on the left], and dorsally. Specimen with high number of triads of small plates on adradial suture beyond petals. The same locality. No. 4603. x 1.2.

Pl. 3

Figs. 1—3 *H. alta*, test viewed dorsally, ventrally, and laterally [anterior part on the left]. Very wide specimen. The same locality. No. 4479. x 1.8.

Figs. 4—5 *H. alta*, test viewed ventrally and laterally [anterior part on the left]. See extraordinarily large peristome. The same locality. No. 5949. x 1.5.

Fig. 6 *H. alta*, enlarged view of apical system. The same locality. No. 8174. x ca. 3.0.

Fig. 7 *H. alta*, enlarged view of apical system of the specimen from pl. 1, fig. 4 (No. 4244, *H. pentagona*). x ca. 3.1.

Pl. 4

Figs. 1—5 *H. alta*, test viewed dorsally, ventrally, and laterally [anterior part on the right]. Figs. 4, 5 — enlarged view of ventral region with different lightnings. The same locality. No. 4527. x 1.9 [figs. 1—3], x ca. 5.9 [figs. 4, 5].

Pl. 5

Figs. 1—4 *H. subcylindrica* SÁNCHEZ ROIG, test viewed dorsally, ventrally, laterally, [anterior part on the left], and ventrolaterally. See enormous plate thickness in broken parts. The same locality. No. 6308. x 1.2.

Fig. 5 *H. alta* (= holotype of *H. pentagona*), posteroventral view. x ca. 1.5.

Figs. 6—8 *H. subcylindrica*, holotype viewed dorsally, laterally [anterior part on the left], and ventrally. The same locality. No. 4195. x 1.5.

Pl. 6

Figs. 1—3, 7 *H. subcylindrica*, hexamerous specimen viewed dorsally ventrally, and laterally [anterior part on the left]. Fig. 7 — enlarged view of apical system. The same locality. No. 4597. x 1.2 [figs. 1—3], x ca. 4.8 [fig. 7].

Figs. 4—6 *H. subcylindrica*, test viewed dorsally, ventrally, and laterally [anterior part on the left]. The same locality. No. 5951. x 1.2.

Fig. 8 *H. sp.*, enlarged view of peristomial region of specimen No. 6266 (see the next plate). x ca. 6.1.

Pl. 7

Figs. 1—3 *H. sp.*, test viewed dorsally, laterally [anterior part on the left], and ventrally. The same locality. No. 6266. x 1.8.

Figs. 4—6 *H. alta*, test viewed laterally [anterior part on the left], dorsally, and ventrally. The same locality. No. 6378. x 1.8.

Fig. 7 *H. subcylindrica*, enlarged view of ambulacrum V. See triads of small plates on adradial suture beyond petal. The same locality. No. 5951. x ca. 12.0.

Fig. 8 *H. subcylindrica*, enlarged view of apical system from plate 5, figs. 1—4. xca. 3.0.

Pl. 8

Figs. 1—3 *H. rojasi* sp. n., holotype viewed dorsally, ventrally, and laterally [anterior part on the right]. Alcalá y Báguanos, Holguín, eastern Cuba. No. 6915. x 1.5.

Figs. 4, 5 *H. sp.*, test viewed dorsally and laterally [anterior part on the left]. Loma Caoba locality. No. 6274. x 1.5.

Figs. 6, 7 *H. sp.*, test viewed dorsally and ventrally. The same locality. No. 4415. x 1.8.

Fig. 8 *H. sp.*, test of partial hexamerous specimen (see also text-figs. 5—8). The same locality. No. 8148. x 1.9.

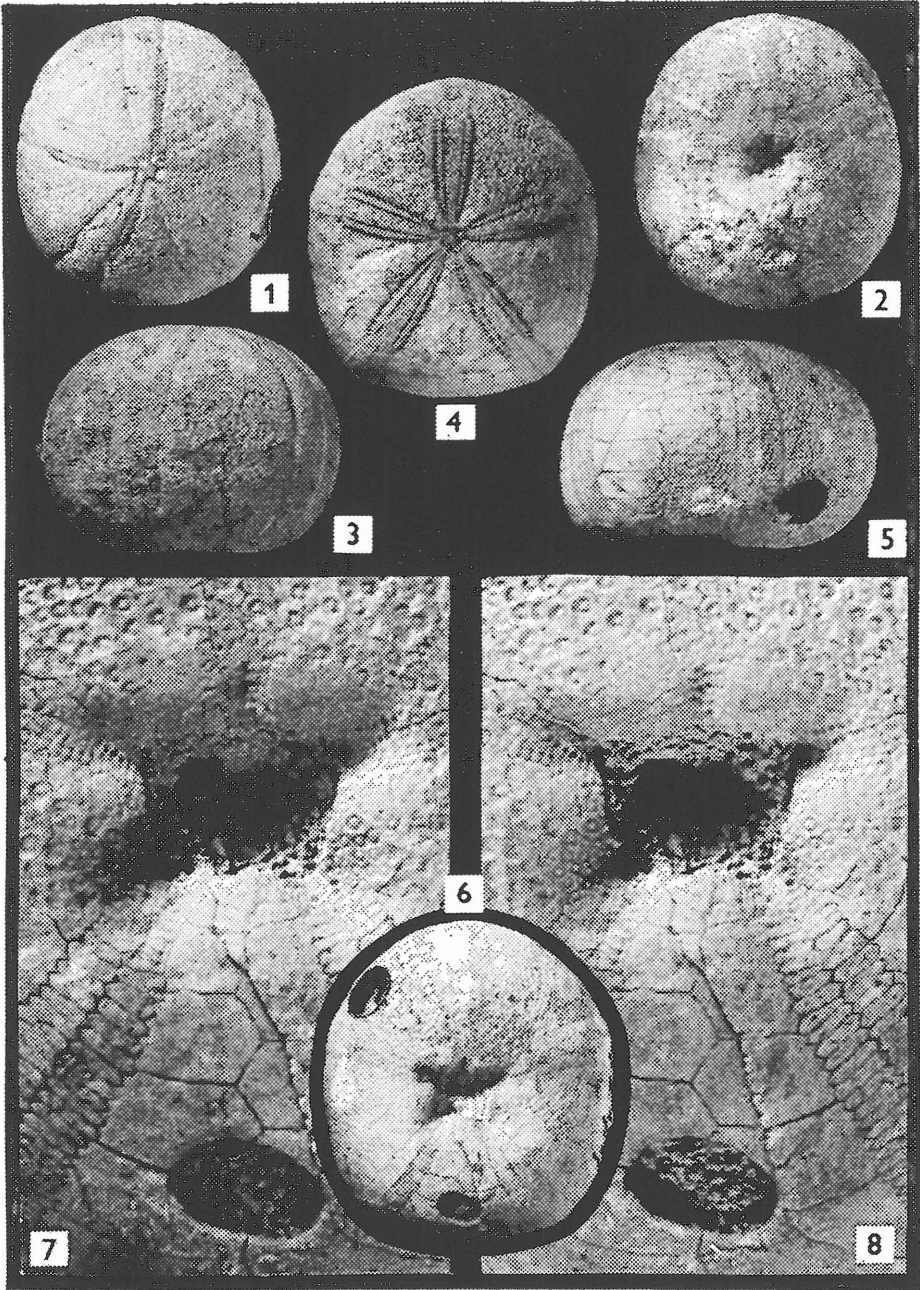

Pl. 1

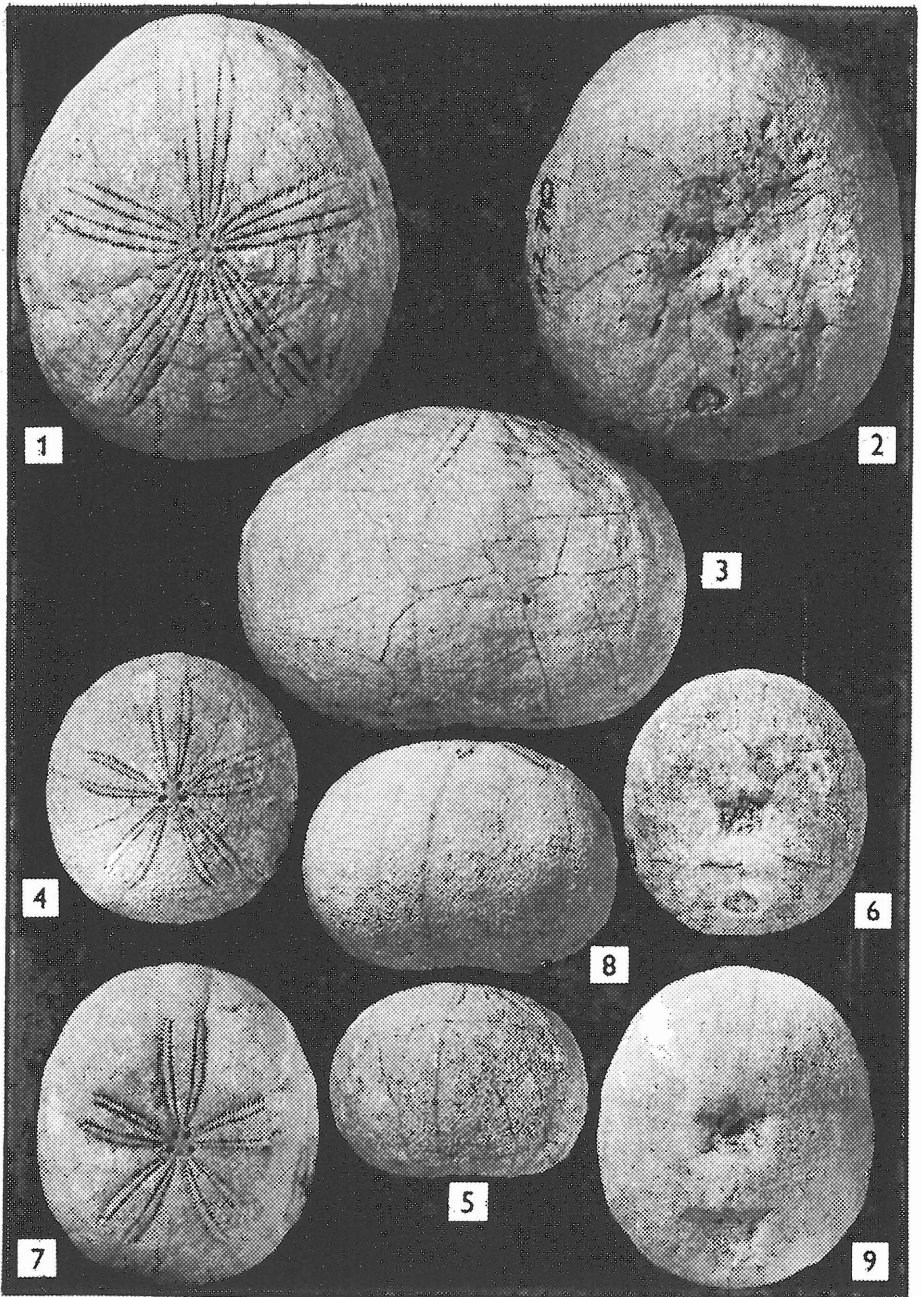

Pl. 2

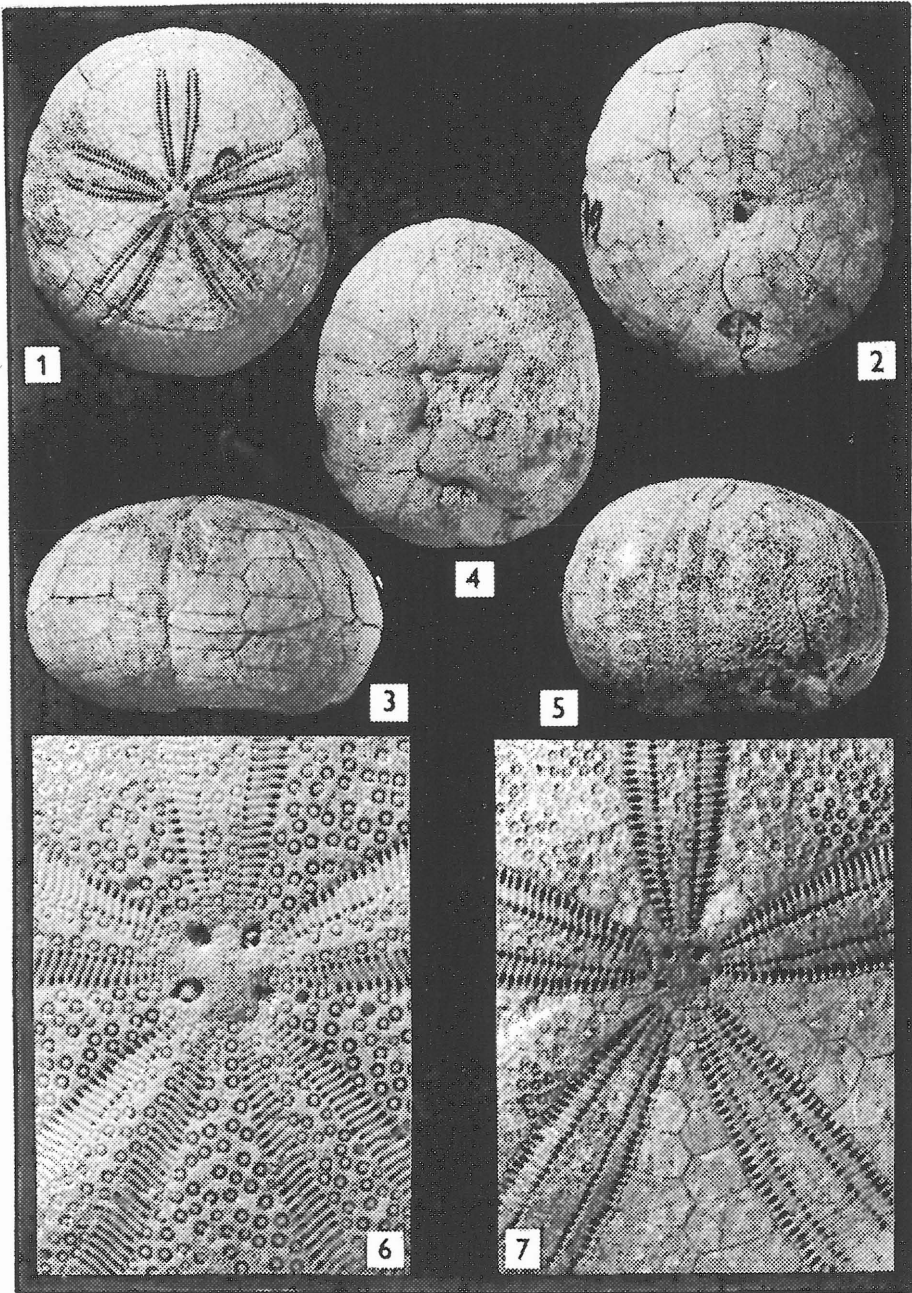

Pl. 3

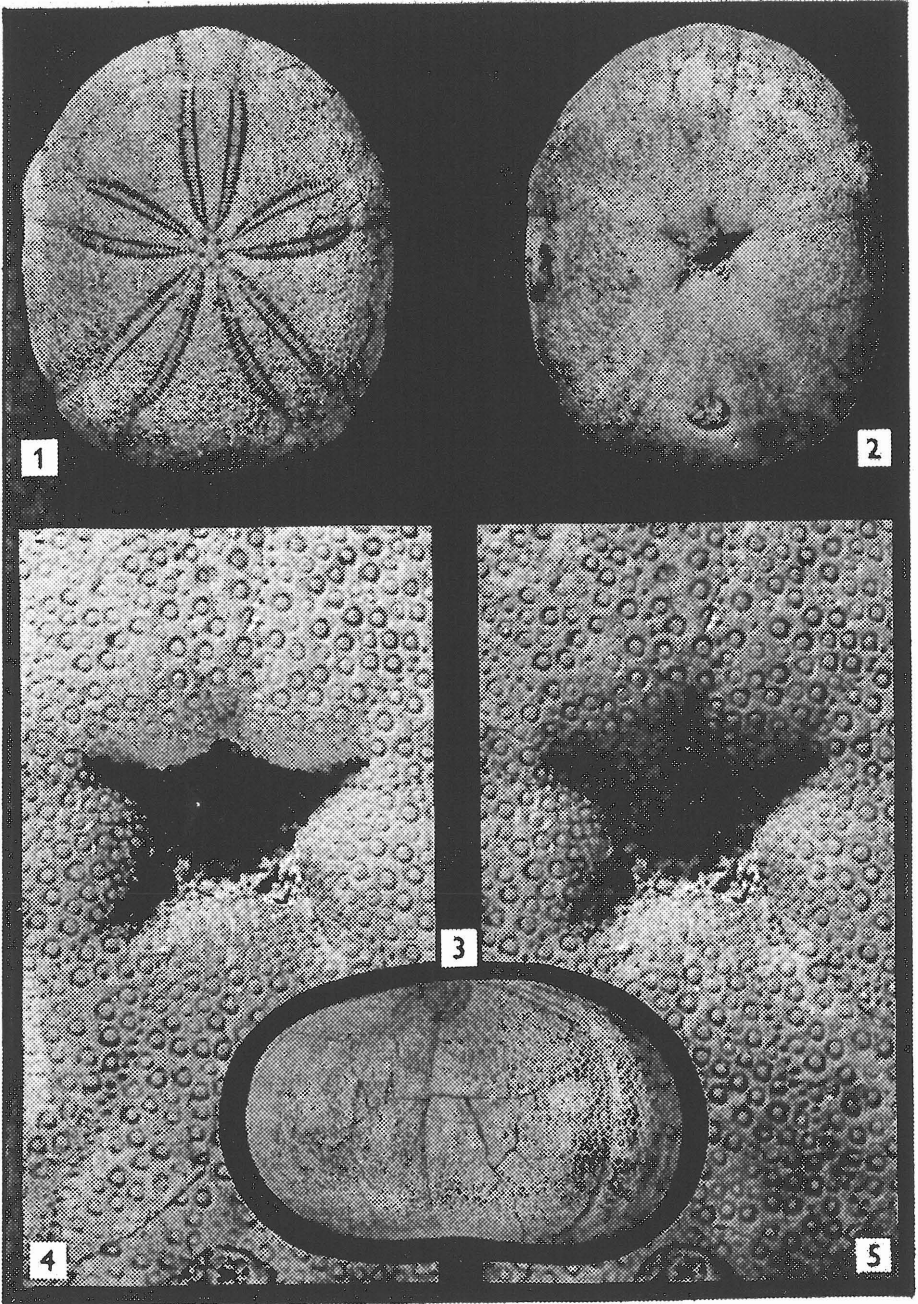

Pl. 4

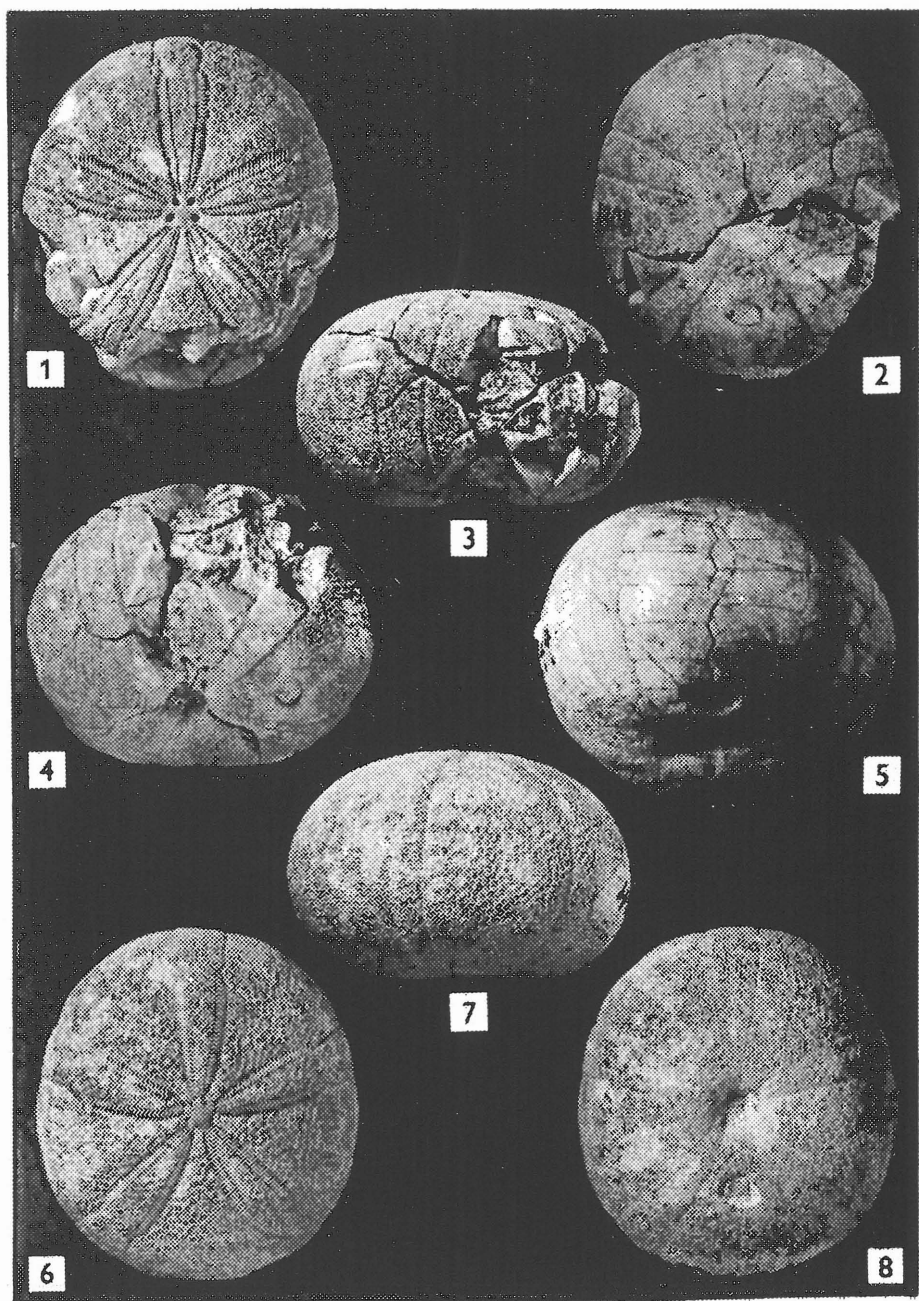

Pl. 5

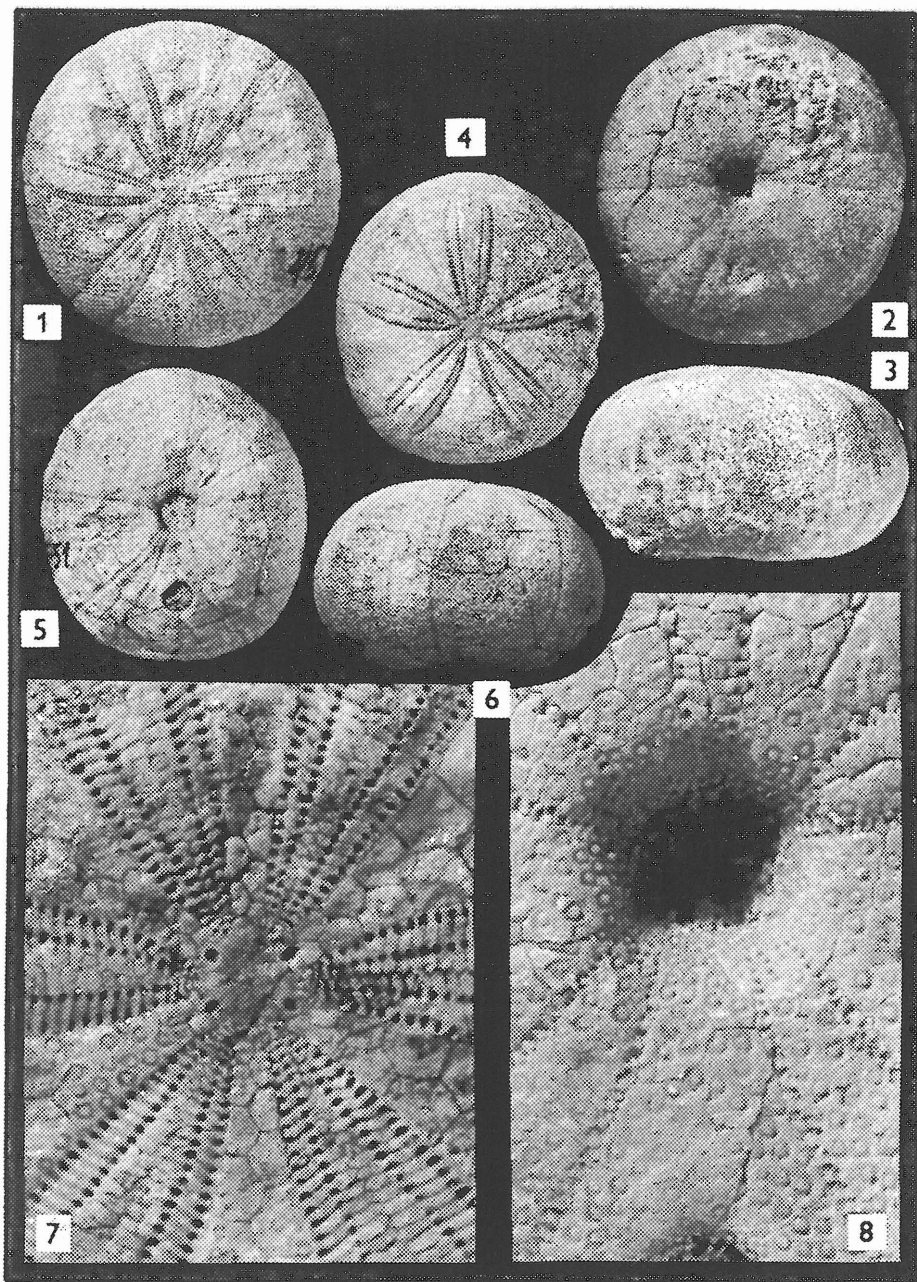

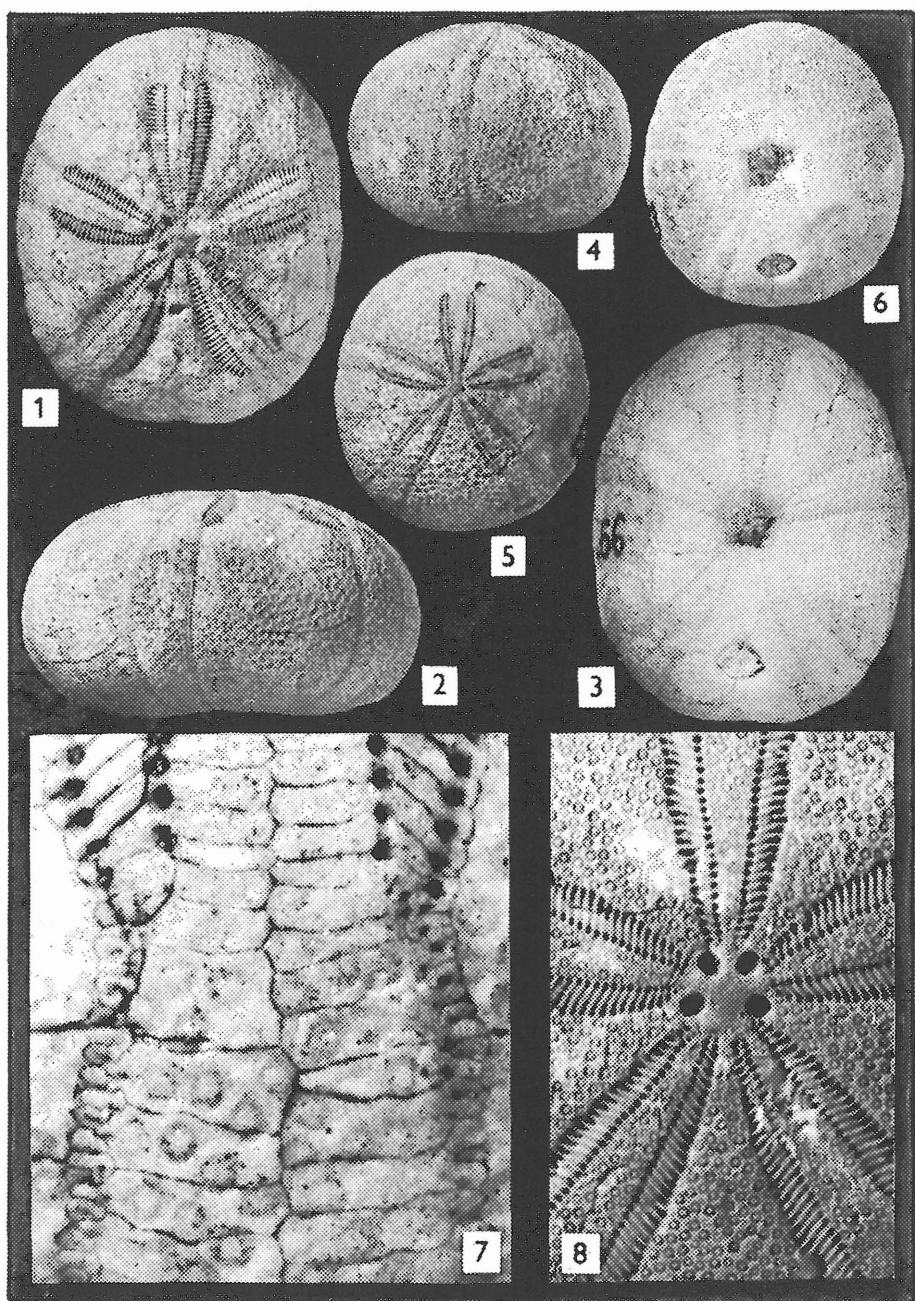

Pl. 7

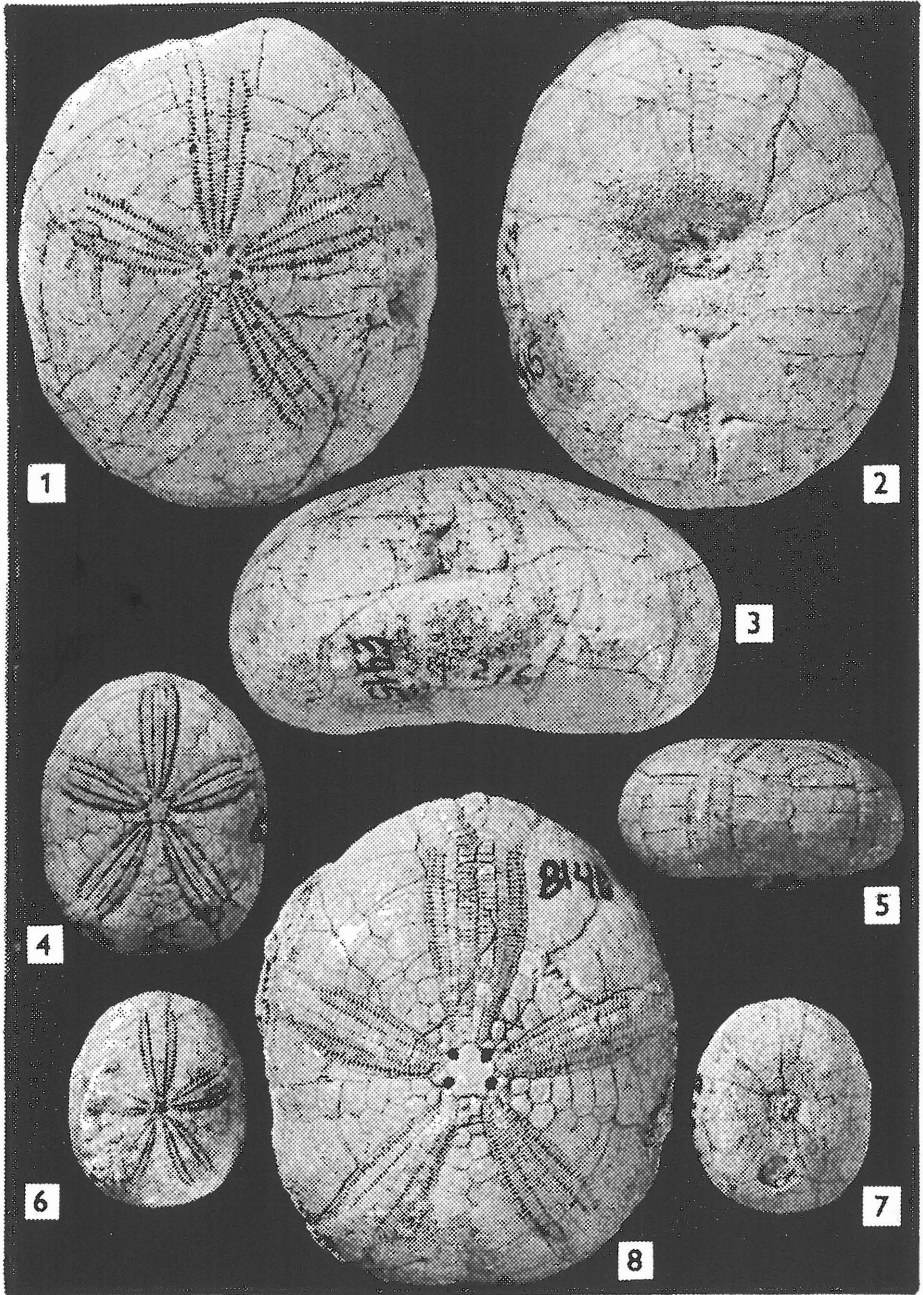

Pl. 8